



# MobiBed

## Mobile aid for the positioning of patients with reduced mobility.

The MobiBed provides varied positioning options in rest and respite situations.

The mobile aid is intended for indoor use. For adults and children of maximum 90 kg.



- ✓ Possible to adjust height, back and leg support with the remote control.
- ✓ The height ensures better working conditions for the staff.
- ✓ Used in institutions in Scandinavia since 2017.
- ✓ Cushions for individual positioning.
- ✓ Additional positioning cushions available.
- ✓ Three length settings in the back part and three in the seat part.
- ✓ Recommended up to 185 cm user height.
- ✓ Bedrails and belts available.
- ✓ Puncture free tires.



# Table of content

1. Safety .....	3
2. Symbols .....	4
3. General comments .....	5
4. Application .....	6
5. Prior to using the mattress .....	9
6. Using the MobiBed.....	11
7. Maintenance .....	16
8. Disposal.....	16
9. Warranty .....	16
10. Specifications .....	17
11. Troubleshooting.....	18
12. Spare parts list.....	19
13. Warning code reference .....	20
14. Accessories.....	21

# 1. Safety

---



## WARNING

Do not use the MobiBed without prior thorough instructions by trained staff or by persons who have received instructions in the use of the MobiBed. Improper operation may cause injury to the patient.

If the MobiBed is used for patients weighing more than the maximum user weight (90 kg), the risk of damaging the MobiBed increases.

Carefully study these instructions for use before using the MobiBed. Pay attention to Safety Instructions indicated by a 

Cobi Rehab accepts no responsibility for damage caused to the product nor for personal injury caused by improper installation, assembly, or use of the MobiBed.

Contact Cobi Rehab immediately in the case of damaged or missing parts. Never use your own spare parts.



## SAFETY INSTRUCTIONS

Ensure that there are no patients, objects, or anything else between or under the moving parts of the cushion frame or the lift arm, between the top bar and the base frame or between the actuators.

Do not elevate the MobiBed when it is positioned under a table or another object. The MobiBed may be damaged, and the patient may be squeezed and sustain injuries.

Ensure that the hands, arms, legs, and feet of the patient do not bump against equipment or passers-by. Also, pay attention in narrow passageways or doorways.

Never lift the MobiBed from the floor/surface by holding onto the leg support and/or the handlebar.

Avoid knocking the front wheel of the MobiBed into edges and the like. This could damage the wheel and the front wheel fork – and, in the worst case – the suspension.

Only move the MobiBed with the patient in it when the cushion frame is lowered into position. This improves stability and provides an unobstructed view of the direction of travel.

Always leave the MobiBed on the brake when not in use.













Never park the MobiBed on a slope while it is occupied by a patient. The brake does not work efficiently on smooth and steep surfaces.













Always activate the locking brake when the MobiBed is occupied by a patient and when parts of the MobiBed are raised or lowered.

Do not use the MobiBed while charging.

Never leave a patient unattended in the MobiBed whether indoors or outdoors.

## 2. Symbols

The following symbols are used in this user manual and/or on the product label.	
	Caution!
	Double isolated (Class II)
	Declaration of conformity, Medical Device Regulation, EU 2017/745
	International electronics approval
IP31	Ingress Protection Ratings Guide
	Type BF applied part
	Recycle: electronic equipment (WEEE)
	Cobi Catalogue number
	Serial number
	Date of manufacture
	Manufacturer
	Medical device
	Body weight
	Consult instructions for use
Label on the MobiBed is located on the left side (seen from the front) by the crossbar at the rear wheel.	

	Cobi Rehab ApS Fuglebæksvej 1D DK-2770 Kastrup Tel.: +45 70252522			
	Reden/Mobibed 0316-100-000			90 KG
	2012345D			
	2020		(01)05740000105439(21)2012345D	

## 3. General comments

---

This user manual contains important information about the use of MobiBed and the target group for the wheelchair. It also includes a wide range of specifications on MobiBed.

The most recent version of this user manual can be found on our website. Check if the version you are reading now is the most recent.

If you need a user manual written in a larger font size, this user manual is available in PDF format at [cobirehab.com](https://cobirehab.com), which can be scaled up to the required font size.

You can always contact Cobi Rehab on telephone +45 7025 2522 or e-mail [cobi@cobi.dk](mailto:cobi@cobi.dk) if you want more information about MobiBed.

Cobi Rehab reserves the right to change the product specifications without providing prior notice.

The UDI number of the wheelchair appears on the label, which is located on the side of the frame.

Product safety notices and product recalls can be viewed on the website (<https://www.cobirehab.com/kunde-hos-cobi/vigtig-produktinformation/>).

### Contraindications

Do not use the MobiBed for patients who are able to move unaided.

Always consult a therapist before allocating a MobiBed to a patient. The maximum user weight is 90 kg.

### Unintended event

Report any incidents relating to the use of MobiBed to Cobi Rehab.

### After expiry of expected service life

After the expected service life, it is important that an overall assessment of the product is made before continued use.

After the expected service life, Cobi Rehab cannot guarantee the suitability and safety of the product, as Cobi Rehab has no control over how the product is used and wear and tear.

The overall assessment of the product must be carried out by qualified professionals, and as a minimum, consideration must be given to how the product has been used, the condition of the product and its components.

Cobi Rehab can always make such an assessment.

 Study the manual in its entirety prior to using the MobiBed

## 4. Application

---

The MobiBed is a mobile aid for the positioning of patients with reduced mobility in need of varied positioning options in rest and respite situations.

The MobiBed with insert cushion is used to provide optimum user comfort whether in a

seated or reclining position as well as in supine or lateral position.

### 4.1 Load and user weight

The user weight is maximum 90 kg. Comply with the stated maximum weight of 90 kg to avoid damage to the MobiBed.

The MobiBed is unsuitable for patients who can move unaided.

Using a lift to transfer patients to and from the MobiBed is recommended.



Minimum length



Maximum length

### 4.2 Mobile aid

The MobiBed is equipped with four wheels with puncture-proof tyres. The front wheels are mounted in a pivoting wheel fork and can turn a vertical 360° which makes the MobiBed easy to

manoeuvre. The rear wheels are mounted on a fixed horizontal axis. The rear wheels have brakes.

### 4.3 One aid - many options

The MobiBed has several adjustment options. It is flexible and easy to adjust to individual patient. The MobiBed:

- is adjustable in terms of the length of the seat and back and may be adjusted to fit both children and adults.
- is adjustable in terms of height to suit the needs of the patient and/or the working position of the helper.
- provides good seated and supine positions using the insert cushions, thus creating stability and a feeling of security.
- has adjustable back and leg support, providing positioning options from horizontal position to 60° seated position.
- is an alternative to a wheelchair, bed, mattress, bean bag, etc.
- is a social tool, as resting does not require a stationary location.

## 4.4 Indoor use

The MobiBed is intended for indoor use. In certain instances, the MobiBed may be used outdoors to a lesser extent and only on flat surfaces such as terraces etc.

## 4.5 Notes on the insert cushions

To provide the patient with the greatest possible support and comfort, the insert cushions must be at the same height in the frame. This means that any difference in height must be eliminated.

The insert cushions are filled with latex and polystyrene pearls (EPS). This mix may collapse

## 4.6 Load

 Ensure that the total weight of the patient and any ancillary equipment do not exceed the maximum weight of 120 kg.

## 4.7 Use a lift

 If at possible, use a lift when transferring the patient to and from the MobiBed. When using a mobile lift, raise the position of the MobiBed to allow the “legs” of the mobile lift to clear the lift arm under the MobiBed.

Please ensure that the patient is correctly positioned in the MobiBed.

## 4.8 No transport by car

The MobiBed must not be used to transport a person inside a vehicle.

The MobiBed is not suited for transporting a person in a moving vehicle.

The MobiBed cannot be used as an outdoor means of transport over longer distances as it is not designed for use in uneven, hilly, or sloping terrain or in water.

over time. Therefore, the purchase of a MobiBed includes an extra bag of filling for the elimination of height differences.

Feel free to contact Cobi Rehab for additional information on how to adjust insert cushions to the needs of the patient.



The MobiBed is not and cannot be crash tested according to E/ECE/324, E/ECE/505 and ISO 717619.

## 4.9 Fastened during transport

The MobiBed is equipped with six fastening points that are used for fastening the MobiBed to the floor of the vehicle.

Follow general safety requirements relating to the fastening of aids in vehicles.

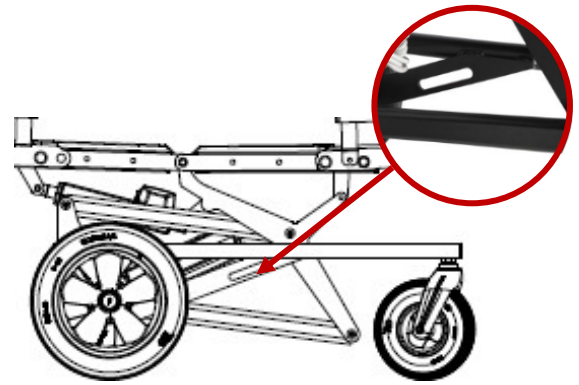

The fastening points are located on the side, in the front of the base frame, and in the back of the base frame.

## 4.10 The cushion frame

Place the insert cushion in the cushion frame/rail. The upper back of the cushion frame, the seat, and the bottom part of the leg support are equipped with a bar which keeps the

cushion/mattress in place.

The cushion frame/rail is not suitable for sitting or lying on. Nor is the leg support suitable for sitting on.

## 4.11 Brake and wheels

The MobiBed is equipped with braking rear wheels but non-braking front wheels. This means that the front end of the MobiBed can pivot and move.

For this reason, neither the patient nor the care staff are permitted to lean on the sides of the MobiBed, not even when the brake is activated.

## 4.12 The use of belts (optional)

 Belts (additional purchase) should be used during transport as well as when the MobiBed is parked. The use of the belt is also recommended for patients who are immobile and unable to move around much unaided.

The use of two crossing belts is recommended for restless patients or patients with involuntary

movements while the patients occupy the MobiBed.

The brake is operated via the brake grip mounted on the handlebar. All four wheels are equipped with puncture-proof tyres.

The brake is a drive brake. It is not sufficiently strong to be able to brake and park the MobiBed on a sloping surface.

The MobiBed is unsuitable for mobile patients who can move unaided.

The belt is fastened on the upper frame of the MobiBed and not the base frame.



# 5. Prior to using the mattress

---

## 5.1 Preparation

Start by making sure that the MobiBed is undamaged and without defects. Charge the battery for 10 hours by connecting it to the mains power supply. Please refer to the guidance on charging, page 10.

Never use the MobiBed in temperatures of less than +5°C or in temperatures exceeding +40°C. If the MobiBed has been stored in very cold or very

hot ambient temperatures, leave it in room temperature for 24 hours prior to use.

Prior to use, clean the MobiBed using a dry, soft cloth.

Study this manual in its entirety prior to using the MobiBed.

## 5.2 Check

Check that:

- The length of the cushion frame matches the insert cushion.
- The brake mechanism is undamaged and working correctly and that the rear wheels are blocked.
- The wheels are without visible flaws and defects.
- The handlebar is properly mounted and adjustable.
- Moveable parts (extension, frame, handlebar, knee joints) move smoothly and are neither fully nor partly blocked.
- The battery is charged, and the charging cable has been disconnected from the mains power supply and rolled up.
- The buttons on the controller work and adjust the height as well as tilting of the back and legs of the MobiBed.

The MobiBed is now ready for use.

## 5.3 Charging and using the battery

The electrical functions of the MobiBed are controlled by the LINAK SMPS system. This system is designed for the healthcare sector and is characterised by improved lifespan, considerable durability, being waterproof, quiet, and environmentally friendly.

The system comprises a control unit with a mains power cable, a lithium battery, three motors and manual control.

## 5.4 Application

The elevating function of the MobiBed as well as the tilting of the back and leg supports are controlled by the keys on the controller. The

battery powers the functions of the actuators as well as the controller.

## 5.5 LED Indikator



CA41 is equipped with a three coloured LED indicator located on the control box. The indicator shows whether the MobiBed is currently operated by power supply or battery supply. The control box is mounted under the frame.

LED colors when connected to power supply	
Green	The MobiBed is operated by power supply. The controller has not been activated. The system is working ok and ready for normal operation.
Yellow	The MobiBed is operated by power supply. The controller has not been activated. The system is defect and should not be operated. Contact Cobi Rehab.
Yellow	The MobiBed is operated by power supply. The controller has been activated. The system is working.

LED colors when connected to battery supply	
Orange	On battery. The controller has been activated. The control box is functioning and operating correctly.
No LED lights	On battery. The controller has not been activated or the control box is not connected to power supply.

## 5.6 Charging

**⚠** When the battery is nearly charged, a beep sound will be issued when the buttons on the manual control are activated. Immediately, charge the battery. Avoid using the MobiBed until the battery is once fully charged.

- Charging time is 10 hours, connected to the mains power supply.
- Operating time is five hours with full charge of a fully efficient battery.
- Fixed routines for charging are recommended, e.g., set the MobiBed to charge at night. It is not possible to overcharge the battery.
- Roll up the mains cable, when the MobiBed is in use.
- With long-term storage of the MobiBed, the battery should be fully recharged every 12 months otherwise it can become damaged, because of self-discharging.
- Store the battery indoors and in a dry space. Do not exposed it to temperatures of less than -10°C or of more than +40°C.
- The operating temperature is +5°C to +30°C.
- Expected lifetime is four years but depends on how the product is used.
- Clean LINAK products at regular intervals to remove dust and dirt. Check for mechanical damage. Replace wear worn parts.

# 6. Using the MobiBed

## 6.1 Controller

The elevating functions of the MobiBed are activated using the controller.

### The functions of the buttons:

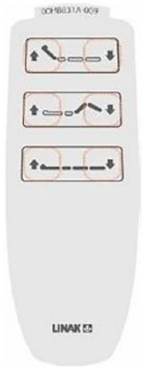

- Top: Adjust the back angle
- Middle: Raise or lower the leg rest
- Bottom: Raise or lower the entire MobiBed

When the controller is not in use, hang it on the hook on the handlebar.

## 6.2 Adjusting the length of the MobiBed

The seat or back of the insert cushion frame may be adjusted lengthwise.

There are three options for positioning the back and three options for positioning the seat, providing a total of nine adjustments of length.

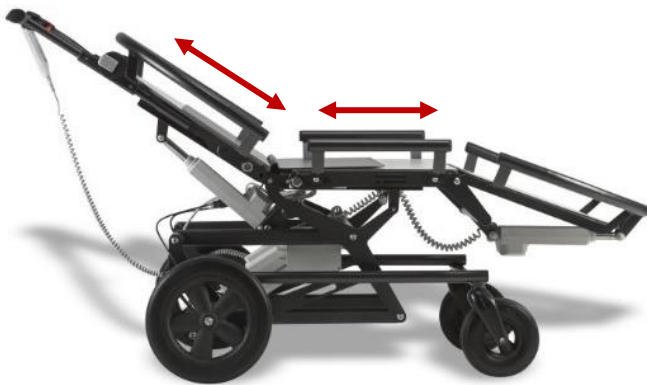

1. Remove the insert cushion.

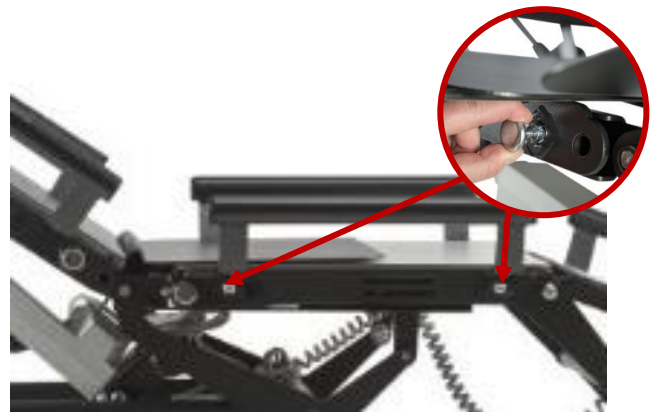

2. On both sides of the bottom of the frame, there is a positioning bolt for the seat and the back. Turn the bolts to the unlocked position.



3. Grab the frame and pull it or push it to the desired position. Lock the bolts on both sides again. Pull or push the frame again until you hear a click. The frame is now locked in position.

## 6.3 Adjusting the length of the MobiBed

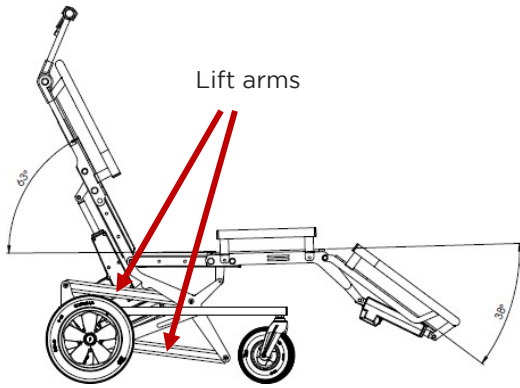

The MobiBed may be continuously adjusted using the lift arms and the electric control unit and battery, actuators, and controller. The elevating function of the MobiBed, the back of the cushion frame and the leg support are controlled using the controller.

When reaching the extreme positions, the elevating function automatically stops.

**⚠** Ensure the bottom lift arm does not bump on obstacles when crossing these.

Use a ramp when loading the MobiBed into a motorised vehicle.

## 6.4 The handlebar

The height of the MobiBed handlebar may be adjusted in two ways. By using the controller and by a step-by-step tilting of the handlebar itself.

A grip (called a knee joint) is located on each side of the vertical control bar. This may be loosened to adjust the tilt of the handlebar.

**⚠** Do not use the handle as a lever handle when the MobiBed crosses doorsteps or similar. It could break.

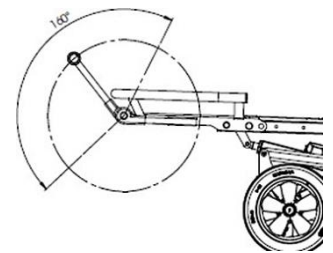

## 6.5 Braking - procedure

The brake is mounted on the rear wheels, and it is only possible to brake those two wheels. The brake grip on the handlebar is equipped with a lock and works as a parking brake. The brake is activated by squeezing the brake grip, thus blocking the wheels. Release the brake by holding in the red plastic part. This releases the brake.

**⚠** Although the MobiBed is equipped with rear-wheel brakes, the front end of the MobiBed can still pivot and move while the rear-wheel brakes are activated. For this reason, the patient and care staff must not lean on the sides of the MobiBed.



## 6.6 The brake system - adjustment

The brake system is adjusted by turning the adjustment screw. Pull the brake cable downwards and then turn clockwise (inwards). This reduces the braking power. If you turn anticlockwise (outwards) the braking power is increased.

Check that the brake cable is not caught between the groove of the adjustment screw and the brake housing. The grooves must not be abreast of each another.



## 6.7 Installation of belts (optional)

Always secure the patient with one or two belts, depending on the movements of the patient. Place the belt across the hip or have them cross each other, if two belts are used. Belts and bedrails can be purchased together with the MobiBed.



Place the belt across the hip of the patient and fasten it as illustrated below.



## 6.8 Module insert cushions



The insert cushions for the MobiBed are available in various measurements and models. They are made from comfortable materials and have removable and washable covers.



On the inside, the insert cushions are equipped with a water-repellent and antibacterial polyester cover.

The cushions are equipped with a non-slip base, ensuring that they stay in place. No extra straps or buckles are required for fastening.

The Module Insert Cushion is constructed from three modules and is comparable to a bean bag. The modules are malleable and adapt to the patient and the base. This provides support and comfort in both seated and supine

positions to patients with scoliosis or other severe deformities.

The inside of the back module is constructed from two separate cushions. The filling of Module A (the smaller cushion) is firmer for the support of head and neck. The filling of Module B is less dense which makes it more flexible. Module B may be moulded to fit the shape and needs of the patient.

The patient may be placed in either a supine or a lateral position. Always use a lift when transferring the patient to and from the MobiBed.



MobiBed with bedrails (additional purchase).



Shape the insert cushion before placing the patient in the MobiBed. In that way, the patient is positioned deep into the material and is thus provided with the optimum support.



Example of supine position with arms supported by a Lasal crescent cushion. The Module Insert Cushion adapts to the shape of the patient and supports the body, the legs, and the feet.



Example of seated position. Positioning cushions support the head and the arms as well as the topmost leg.

## 6.9 Mattress with positioning cushions

The mattress comprises a Tempraflex viscoelastic foam mattress on which the bedding of the patient is built up using loose positioning cushions. In this way, an individualised position may be established for the patient.

The positioning cushions may also be used for positioning the patient in the patient's bed.

The Tempraflex mattress is available in three lengths and is equipped with an inside water-repellent and antibacterial polyester cover.

The mattress is also equipped with a non-slip base, ensuring that it stays within the frame. Therefore, no extra straps or buckles are required for fastening.



The outer cover on the top part, which is the back, is equipped with straps for the fastening of positioning cushions.



Straps and belts keep the patient and the positioning cushions in the desired position.



Depending on the position and the needs of the patient for support, the loose positioning cushions are placed to create a nest.



The positioning range for The MobiBed combined with the LASAL cushions provide the best individual positioning options.

MobiBed positioning cushions are filled with EPS pearls in a water-repellent and antibacterial polyester cover. The cushions are available with removable and washable covers.



Wedge Cushion



Neck Cushion



Gouda Wedge Cushion



Triangle Cushion

# 7. Maintenance

---

## 7.1 Cleaning the MobiBed

Clean the MobiBed using a soft cloth and water, possibly adding a small amount of dish soap or the like.

Raise the MobiBed to maximum height so that the tiltable cushion frame is at more than 45° and the leg support is elevated to 20°. This way, all surfaces are accessible. Remember to activate the locking brake during cleaning.

## 7.2 Cleaning of the cushions

The coverless insert cushion is made from 100% PU-covered and fire-repellent polyester. Clean the cushion with a soft cloth and water with a mild detergent added. The insert cushion cannot be washed in the washing machine.

### Disinfection

Disinfect the surfaces of the insert cushions using single-use cloths with ethanol or a chlorine product of 1000-1200 ppm.

Clean wheels and wheel suspensions if they have become soiled.

### Disinfection

Disinfect the surfaces of the MobiBed using single-use cloths with ethanol or a chlorine product of 1000-1200 ppm.

Always disinfect the MobiBed when preparing for a new patient to avoid cross-contamination.

Always disinfect the insert cushions when preparing for a new patient to avoid cross-contamination.

### Outer covers for insert cushions

Two types of outer covers are available:

- Grey cover (Lenzing/Tencel). Washable at 60°C. Tumble-dry at low heat.
- Black cover (100% polyester). Washable at 40°C. Do not tumble-dry.

# 8. Disposal

---

Products which are no longer in use, must be responsibly disposed of.

Contact the relevant local authorities for guidance on correct disposal.

# 9. Warranty

---

Cobi Rehab warrants that the MobiBed is without defects on delivery. If, against all expectations, the MobiBed is subject to deficiencies or defects on receipt, please contact Cobi Rehab immediately.

The warranty period for the MobiBed is one year from the date of purchase. The invoice is your certificate of warranty.

The warranty does not apply to:

- products on which the serial number, batch number or the like have been removed or significantly damaged

- products which have been repaired by unauthorized personnel

- normal maintenance such as cleaning, adjustment, lubrication and updating of equipment or parts.

This warranty does not cover the MobiBed when Cobi Rehab assesses that the MobiBed has been improperly handled, e.g., if the maximum user weight has been exceeded.

For damage caused by improper operation, an invoice will be issued for both the service and the spare parts used.

The above warranty is the only warranty offered.

Cobi Rehab cannot be held liable for damage or injury of any kind.



## 10. Specifications

Max. length with handlebar and leg support fully extended	2150 mm
Max. width of the MobiBed measured across cushion frame bar	720 mm
Height of cushion frame measured from floor to top of bar Lowest position / Highest position	550 mm / 850 mm
Cushion frame length (adjustable) Min. length / Max. length	1460 mm/ 1830 mm
Max. reclining dimension fully extended: with Mobilia Mattress (person height max. 172 cm) with Mobilia Module Insert Cushion (person height max. 180 cm)	1835 mm 1930 mm
Wheelbase between front and rear wheel measured from the middle of axle to middle of axle 720 mm	720 mm
Total weight without inserts cushions 55 kg	55 kg
Load capacity: Safety tested to	120 kg
Utilization weight (max. person weight) recommended	90 kg
Front wheel/ Rear wheel diameter	200/300 mm
Actuator, motor, lift, back tilt, and leg tilt - LINAK LA40-100 24 V	Load 4000 N
Control box - LINAK CA41 - SMPS - IPX6	24 V
Built-in charger in control box. To charge connect: 100V/240V	100V/240V
Manual control LINAK HB83 3-way	
Expected product service life	7 years
Basic UDI-DI	5740000100013N3
UDI-DI	5740000105439
Risk class	1
ISO EN 12182: 2012, EN 1970:2002, EN 1970/A1:2005, EN 60601-1/Corr. 1 + Corr. 2: 2008, EN 60601-1-2:2007, EN ISO 10535:2007, EN ISO 12952:1998, EN ISO 12952-3: 1998	
Minimum dimension, e.g., packed for transport, folded together and lowered to the lowest position, back raised to maximum, lowest leg support and handlebar pushed fully forward.	(L)1340 X (B) 720 X (H) 1070
The user manual is available on the website and can be scaled up to a very large font for the visually impaired.	

# 11. Troubleshooting

Problem	Check	If yes	If no
The raise/lower function or tilting mechanism does not work.	Is the battery charged?		Recharge it.
	Is something trapped?	Free it.	
	Is the controller visibly damaged?	Replace with another controller.	
	Are all the plugs correctly connected in the control box?		Connect them correctly.
If the problem persists, contact Cobi Rehab.			
The brakes are not working.	Is the cable intact?		Adjust the brakes. See instructions on page 13.
If the problem persists, contact Cobi Rehab.			
Front wheels do not turn	Any loose bolts?	Retighten them.	
	Is the wheel suspension loose?	Retighten it.	
	Any damaged parts?	Contact Cobi Rehab.	
	Is something trapped?	Free it.	
If the problem persists, contact Cobi Rehab.			
Front wheels do not turn	Are the brakes activated?		Adjust the brake cable. See instructions on page 13.
	Are all the parts intact?		Repaired or replaced if broken. See spare parts list on page 19.
If the problem persists, contact Cobi Rehab.			

## 12. Spare parts list

Pos. Nr.	Ordering No	MobiBed	Total
2	163020	Actuator LINAK LA40, used for lift, back tilt and leg tilt	Qty. 3
3 - -	163000 163001 163002	Control box LINAK CA41 incl. mains power cable Extra net cable Lithium battery	Qty. 1 Qty. 1 Qty. 1
11	163044	Rubber for handlebar	Qty.2
17	163030	Front wheel Ø200 mm excl. fork and bearings	Qty.2
18	163031	Wheel fork for front wheel with bearings (left/right)	Qty.2
16 & 19	163040 (rig) 163041 (left)	Rear wheel Ø300 mm with drum brake	Qty.2
22	163050	Laminate plate - back	Qty. 1
22	163052	Laminate plate - leg support	Qty.1
27	163051	Laminate plate - seat	Qty.1
35	163045	Knee joint for adjusting the handlebar - right	Qty.1
35	160346	Knee joint for adjusting the handlebar - left	Qty.1
34	163042	Brake grip	Qty.1
El. III.	163010	Controller LINAK HB83 3-way	Qty.1

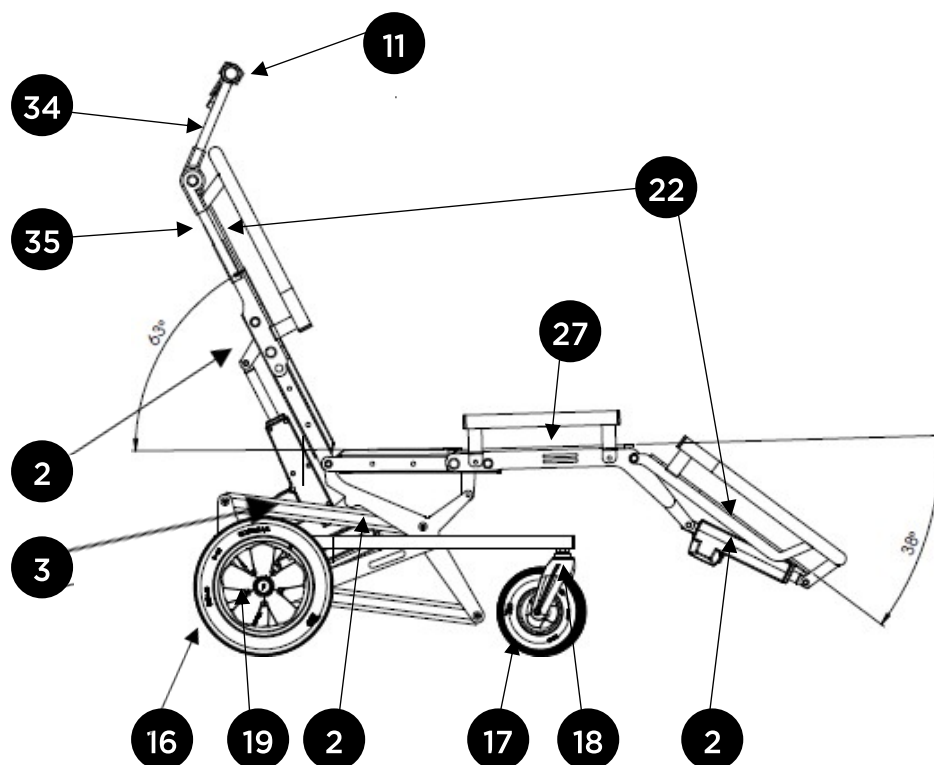

## 13. Warning code reference

---



CA41 is equipped with three colored LED indicators, which show whether the unit is currently operated by mains power or battery power.

<b>LED colors when connected to power supply</b>	
Green	The MobiBed is operated by power supply. The controller has not been activated. The system is working ok and ready for normal operation.
Yellow	The MobiBed is operated by power supply. The controller has not been activated. The system is defect and should not be operated. Contact Cobi Rehab.
Yellow	The MobiBed is operated by power supply. The controller has been activated. The system is working.

<b>LED colors when connected to battery supply</b>	
Orange	On battery. The controller has been activated. The system is working.
No LED lights	On battery. The controller has not been activated or the LED Indicator is not connected to power supply.

## 14. Accessories

---

<b>Accessories</b>	<b>Length</b>	<b>Width</b>	<b>Height</b>	<b>Article number</b>
Triangle Cushion including cover	86 cm	24 cm	21 cm	0316-4531-000
Wedge Cushion, including cover	45 cm	64 cm	10 cm	0316-4541-000
Gouda Wedge Cushion, including cover	30 cm	31.5 cm	4 cm	0316-4521-000
Neck Cushion, including cover	36 cm	6.5 cm	10 cm	0316-4511-000
Belt, size S	125 cm	10 cm		0316-6201-000
Belt, size L	137 cm	10 cm		0316-6221-000
Bedrail				0316-999-090



# COBI REHAB

---



## MANUFACTURER

**Cobi Rehab**  
Fuglebækvej 1D  
DK-2770 Kastrup  
Denmark  
+45 7025 2522  
[cobirehab.com](http://cobirehab.com)