



USER MANUAL

Cobi Cruise Power bariatric comfort wheelchair

The Cobi Cruise Power comfort wheelchair is the most powerful wheelchair on the market for use in the rehabilitation of bariatric users.

The Cobi Cruise Power comfort wheelchair is used in care centres, hospitals, home care settings, and private residences, catering to bariatric individuals requiring a pressure-relieving seat and enhanced comfort.



UP TO 325 KG

- Used in all phases of rehabilitation, from the bedridden user to the mobile user.
- The Cobi Cruise Power comfort wheelchair is equipped with electric propulsion, tilt-in-space and recline functions which are activated via a joystick and operated by both user and care staff.
- Fits through most doorways.
- Armrests that can be angled and pushed away for e.g., transfers or social activities at a table.
- Disinfectable and washable in laundry room at e.g., a depot or a hospital.
- Crash tested, according to ISO 7176-19



Contents

1. Safety	3
2. Symbols	4
3. General comments	5
4. Application	5
5. Construction	6
6. Electric tilt-in-space and recline	9
7. Travel	10
8. Before use	10
9. Possible adjustments	11
10. Maintenance and cleaning	12
11. Transport and storage	12
12. Recycling and disposal	13
13. Warranty	13
14. Specifications	14
16. Accessories and spare parts	16
15. Technical data: Charger	16

1. Safety



WARNING

Do not use the Cobi Cruise Power comfort wheelchair without thorough instruction from trained staff or from persons who have received instruction in the use of the wheelchair. Improper operation may injure the user.

Using the Cobi Cruise Power comfort wheelchair for people weighing more than the maximum user weight of 325 kg increases the risk of damaging the wheelchair.

Read this user manual carefully before using the Cobi Cruise Power comfort wheelchair. Pay particular attention to Safety Instructions marked .

Cobi Rehab assumes no responsibility for any damage to the product nor for personal injury caused by incorrect installation, incorrect mounting, or incorrect use of the Cobi Cruise Power wheelchair.

Immediately contact Cobi Rehab if parts are damaged or missing. Never use your own spare parts.

Cobi Rehab cannot be held responsible for errors or accidents occurring after repairs are made without the written permission of Cobi Rehab.



SAFETY INSTRUCTIONS

In this user manual, the symbol  indicates a safety instruction. Follow safety instructions carefully.

The care staff assesses whether the user should be restrained in the Cobi Cruise Power comfort wheelchair during use for safety reasons.

Always lift users not able to stand and walk in and out of the Cobi Cruise Power comfort wheelchair.

Always take care when using the tilt-in-space and recline function to avoid jerky movements.

The maximum user weight of the Cobi Cruise Power comfort wheelchair is 325 kg.

The stopping distance on slopes can be significantly longer than on even ground.















The surface temperature can rise when the wheelchair is exposed to external heat sources e.g., sunlight.













Due to their large width, certain Cobi Cruise models may have difficulty passing through ordinary doorways and emergency exits.

Always use helper control for users with impaired cognitive function.

Always ensure that the electric functions are charged.

2. Symbols

	Caution!
	Double insulated (class II)
	Declaration of conformity, Medical Device Regulation, EU 2017/745
IPX4	Water resistant
	Max. 10° slope of ground
	Tie-Down brackets for fastening the wheelchair in a motorised vehicle.
	Crash tested according to ISO 7176-19
	Dispose of through correct waste management
	Cobi Catalogue number
	Serial number
	Year of manufacture
	Manufacturer
	Medical device
	Max. user weight
	Consult the manual
<p>CE-Label located at the frame.</p> <p>See an example of CE-Label beneath.</p>	

	Cobi Rehab ApS Fuglebækvej 1D DK-2770 Kastrup Tel.: +45 70252522			
	Cobi Cruise 60 0115-060-000			325 KG
	2012345			
	2021		(01)05740000108577(21)2012345	
				Made in EU

3. General comments

This user guide contains important information about the use of Cobi Cruise Power and the target group for the wheelchair. It also includes a wide range of specifications on the Cobi Cruise Power.

The most recent version of this user guide can be found on our website. Check if the version you are reading now is the most recent.

If you need a user guide that is written in a larger font size, the product sheet is available in PDF format at cobirehab.com, which can be scaled up to the required font size.

You can always contact Cobi Rehab on telephone + 45 7025 2522 or cobi@cobi.dk if you want more information about the Cobi Cruise Power.

Cobi Rehab reserves the right to change the product specifications without providing prior notice.

The UDI number of the wheelchair appears on the label, which is located on the side of the frame.

Product safety notices and product recalls can be viewed on the website.

Crash tested

The Cobi Cruise Power comfort wheelchair is crash tested according to ISO 7176-19.

4. Application

The Cobi Cruise Power comfort wheelchair is designed for indoor use, e.g., in hospitals, institutions and in care homes. The wheelchair can also be used in private homes.

The Cobi Cruise Power comfort wheelchair is intended for bariatric users up to 325 kg whose ability to stand and walk is limited.

The intended operator of the wheelchair is a health professional, such as a therapist, nurse, or a social and health worker.

The intended operator could also be the bariatric user with trunk stability and the ability to drive, control and stop the wheelchair.

The Cobi Cruise Power comfort wheelchair can be used in ambient temperatures of 0°- 40°C and a humidity of 20 - 80%.

The Cobi Cruise Power comfort wheelchair can also be used outdoors but is primarily for indoor use.

The design of the Cobi Cruise Power

The design of the Cobi Cruise comfort wheelchair addresses the daily challenges faced by bariatric users, aiming to enhance their quality of life.

Evaluated by Danish bariatric users, the development of the Cobi Cruise comfort wheelchair has benefitted from valuable suggestions for improvement.

Operating a Cobi Cruise comfort wheelchair provides the freedom to move. Users are able to transition from a state of bedridden dependence to newfound autonomy.

Furthermore, the Cobi Cruise embodies high degrees of safety, benefiting both the user and the caregiver.

Counter indications

Always monitor and guide users with reduced cognitive function in the user of the electrical functions of the wheelchair.

Crash tested in accordance with the ISO 7176-19 standard

The Cobi Cruise Power comfort wheelchair is crash tested which means it can be used in Community Transport vehicles or adapted vehicles for transporting wheelchair users without them being removed from the wheelchair itself.

The wheelchair will need to be secured to the vehicle by a Transit Tie Down System (accessory).

Safe transport is a key element in a wheelchair user's ability to access medical facilities as well as to improve quality of life, by being able to enjoy day trips out and holidays.

5. Construction

The Cobi Cruise Power comfort wheelchair is constructed from type-S355, high-tensile steel. The rectangular steel profiles of the chair form the basis for its base frame. The base frame is made up of two mirror-inverted parts (a right and a left part) connected by a centre module. This structure allows the sides to be reused if the width needs changing.

The seat frame of the wheelchair consists of 30x30x2 mm high-tensile steel profiles. In addition, the seat frame has a 2 mm steel seat plate attached to it, which helps to distribute the pressure in the best possible way.

The back of the wheelchair consists of a high-tensile steel profile. The profile is positioned centrally on the back of the wheelchair. The angle of the profile means that the back supports both apple-shaped and the pear-shaped users. Three back plates are mounted on the profile. The back plates are curved to hug and support the user from buttocks to neck.

Pear-shaped users with voluminous backsides are ensured good back support, as the design of the "spine" of the wheelchair and its lower back plate provide space for the backside.

The upper two back plates ensure that apple-shaped users enjoy stable and comfortable back support.

The back cushion is divided into nine modules, which are sewn together into one large cushion. All nine modules consist of two parts. A firm foam layer and layer with a mixture of polystyrene beads and latex foam.

The foam layer faces the back of the wheelchair while the bead and foam layer are the one sat on by the user. The bead and foam mixture are modular and helps to increase the comfort of the wheelchair and its pressure relieving effect.

The contents of in each cushion module can be adjusted. This means that, according to professional assessment, the therapist or care staff can add or remove beads and latex foam. If necessary, a wedge cushion can also be inserted in one or more modules. The cushion contents are adjusted via the nine zippers located on the back of the cushion.

The modular cushion follows the shape of the back plates and, thus, ensures correct support regardless of user body shape and needs.

The modular cushion can be finely adjusted using a patented FitGo system known from ski boots and work shoes. The FitGo system is located on the back plates.



Curved back plates support and hug the user from buttocks to neck.

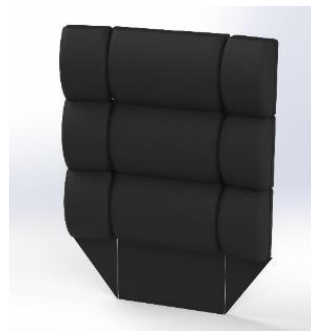

The back cushion is made up of nine modules sewn into one large cushion.

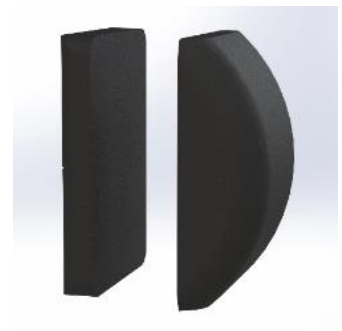

Each of the nine back cushion modules of the back cushion consists of a firm foam layer and a layer of beads and latex foam.

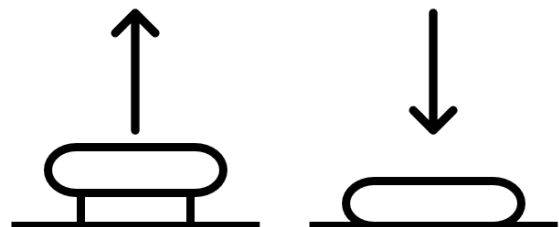

The FitGo system comprises an adjusting knob. The button is activated when pressed. If the button is to be loosened, pull it upwards and the cord pull is then released.

⚠ The FitGo system should only be adjusted by care staff as improper pressure distribution may harm the user.

5.1 The seat cushion

The base of the seat cushion consists of hard foam. The core of the seat cushion consists of memory foam specially selected for the target group.

The top consists of soft foam. The seat cushion is upholstered with a flame retardant incontinence cover.

5.2 Arm rests

Extra-long armrests (615 mm) ensure stability and a good grip when the user moves from a standing to a sitting position or vice versa.

The armrests can swivel back, making it easier to move the user from e.g., the chair to the bed. The armrests can also be pushed down making it possible to move the wheelchair closer to the edge of a table, allowing the user to participate in social activities there.

The armrests are padded for extra comfort and "cup-shaped" thus reducing the risk of pressure ulcers. Each armrest can withstand a maximum load of up to 200 kg.

 The user may fall out of the wheelchair if the arm rest is pushed back.

5.3 Push bar

The push bar is flexible and adjustable, using a click system. Major adjustments can be made with tools. The bar has several grip points, depending on whether the chair is to be pushed or manoeuvred.

 Ensure that the handlebar is in place.

5.4 Leg rests

The leg rests each support up to 200 kg and are adjustable in both height and position. They also have a swivel function that allows easier access to and from the wheelchair.

The angle of the foot plates, the height/angle of the leg rest and the angle of the calf plates can be adjusted without tools.

The position of the foot and calf plates is adjusted using a 10 mm closed spanner and a Torx 25. The closed spanner and the Torx 25 are not included in the purchase of the wheelchair.

The flexibility of the leg rests means that the user's legs can always be supported. This benefit, among other, users with a significant tissue on their inner thighs.

The leg rests may be removed without the use of tools without affecting stability.

 Do not use the leg rests when getting in and out.

 | 2023-09 User Manual of the Cobi Cruise Power Bariatric Comfort Wheelchair



The seat cushion is made up of three different types



Swivelling arms rests allow positioning near



Leg rests each supporting up to 200 kg.



The leg rests can be dismantled without using tools.

5.5 Neck support

The Cobi Cruise Power comfort wheelchair neck support is an option. The wheelchair is supplied with a universal neck support bracket, allowing for the installation of different types of neck support.

5.6 Wheels

The Cobi Cruise Power comfort wheelchair is equipped with two 12,5" massive tyres in grey nylon rubber that does not mark floors. The tyres are mounted on aluminium rims.

5.7 Anti-tip

The Cobi Cruise Power comfort wheelchair is installed with anti-tip that can be adjusted to suit the terrain. Only remove the anti-tip when transporting the wheelchair without a user.

 Risk of tipping when anti-tip is removed.

5.8 Brakes

The brake of the power wheelchair is integrated into the motor. This means that when the joystick is disengaged, the wheelchair stops.

5.9 Actuators

The Cobi Cruise Power has three actuators. Two seat actuators and a back actuator. The two seat actuators control the tilt-in-space function. The seat actuators are installed under the seat.

The back actuator controls the recline function. The back actuator is also installed under the seat.

5.10 Charger

The Cobi Cruise Power comfort wheelchair must be charged until the battery indicator reaches 100%. A full charge can take up to six hours.

When charging the functions of the wheelchair cannot be operated.

The Cobi Cruise Power comfort wheelchair is charged using the port on the back of the joystick.

The battery is installed on the base frame.

5.11 Control box

Dismantling the control box requires tools but should only be undertaken by Cobi Rehab service engineers.

The electronics are IPX4-classified. This means that the wheelchair and its components can withstand a light rainfall.

The electronics of the wheelchair does not disturb the operation of units in the surrounding environment which emit electromagnetic fields,



A universal neck support bracket permits the installation of several types of neck supports.

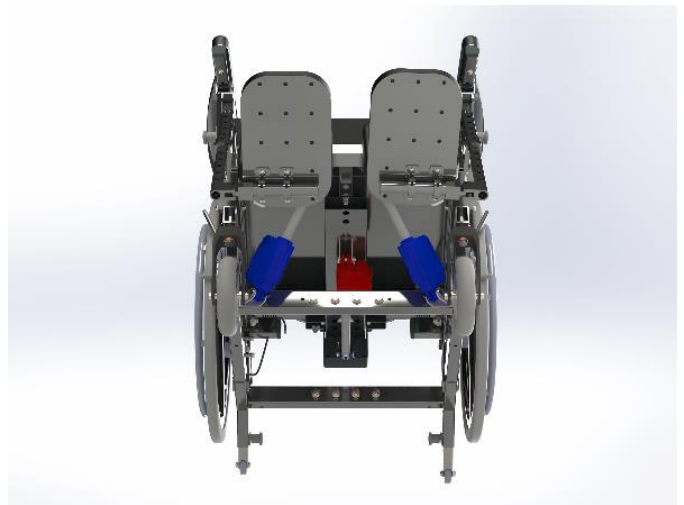

Two actuators (marked blue) control the tilt-in-space function. One actuator (red) controls the recline function.



e.g., alarm systems in shops, automated doors, etc.

The electronics of the wheelchair do not affect electromagnetic fields emitted by e.g., laptops and electricity generators.

6. Electric tilt-in-space and recline

Negative tilt helps the independent user in safely getting in and out of the wheelchair. Negative tilt means that the front of the seat cushion is lowered. This reduces the access height which, in turn, makes getting in and out easier for the independent user. The function negative tilt is activated using the joystick.

Recline provides the apple-shaped user with supported and comfortable seating. When the back of the wheelchair is tilted backwards, the pelvis of the user is automatically opened. This

6.1 Joystick

The supplied joystick allows care staff and user to manoeuvre the wheelchair and to adjust the angle of the seat and back (tilt-in-space $-4-13^{\circ}$ and $90-120^{\circ}$ recline).

The joystick is installed on the supplied swivel bracket and can be positioned on either the inside or the outside of the arm rest.

 Risk of crushing fingers in the joystick swivel bracket.

The joystick has:

- An on/off button
- A button with a horn
- A display showing the battery capacity, time, speed, and travel mode
- two buttons marked *Mode* and *Profile*
- a twin button for controlling speed.

Display

The battery capacity is displayed at the top. Avoid travelling long distances on low battery capacity.

At the bottom, a number between 1 and 3 is displayed. The number indicates the drive mode, where 1 is manoeuvring, 2 is indoor and 3 is outdoor. Each drive mode has five speed steps. The speed in km/h is displayed above the five speed steps (Up to 6 km/h). The speed is displayed in numbers and illustrated with a speedometer.

Profile switches between drive modes 1 to 3.

Press *Mode* to switch between driving and seat and back adjustment. Use the up-down movement of the joystick to control the tilt-in-space function. Switch between the tilt-in-space and recline function by moving the joystick right or left.

When the back and seat are tilted into an unstable function, speed options are restricted. This is indicated by an orange or red turtle being displayed.



provides improved respiration for apple-shaped users. The recline function is controlled using the same joystick as for the electric tilt-in-space function.

 Erroneous use of the tilt-in-space and recline functions can lead to the user experiencing respiratory difficulties, including users with impaired cognition.

 Using the negative tilt function may cause the user to slide forward.

An extra joystick controlling the same functions can be installed on the handlebar. This joystick can also determine who controls the wheelchair. In this way, the user's option of controlling it can be activated or deactivated.

 Do not allow users with involuntary movements to operate a joystick.

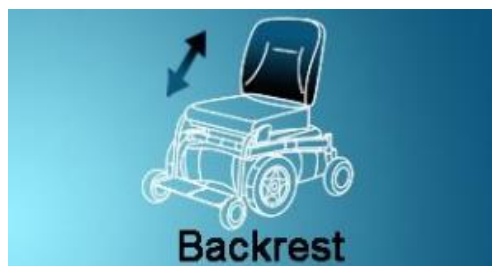

7. Travel

The Cobi Cruise Power comfort wheelchair can reach a speed of up to 6 km/h. The maximum range is approx. 9 km at full load. The theoretical manoeuvring distance is 3.9 km at full load.

The Cobi Cruise Power comfort wheelchair can traverse edges and doorsteps of up to 50 mm. It is also built to be able to drive up and down hills

and ramps of a 10° incline. For the user, it means freedom to get around both indoor and outdoor.

⚠ Max incline of ground is 10°.

⚠ When driving on sloping ground, drive as straight as possible.

8. Before use

When the user is placed in the wheelchair for the first time, the need for extra filling in the various back modules must be professionally assessed.

If extra filling is needed, move the user out of the wheelchair, after which professionally trained staff adds or removes filling from the cushions in question.

If additional support is needed, a wedge system can be used. This assessment is made by professionally trained staff during the actual adjustment.

The wheelchair system is switched on using the on/off button on the joystick. When the system is switched on, it is possible to travel and adjust the seat and back.

8.1 From bed to wheelchair

If the user can independently move from bed to wheelchair:

- Swivel the footrests to the sides
- Adjust the seat angle to the needs of the user
- The user sits in the wheelchair
- Swivel the footrests back into position if required for the activity.

When moving a passive user from bed to wheelchair using a sling:

- Swivel the footrests to the sides if required by the user
- Adjust the seat angle to the needs of the user
- Adjust the hip angle of the backrest depending on the needs of the user
- Tilt the wheelchair backwards
- Slide back one arm rest. Lift user sideways into the chair.
- Swivel back the footrests.

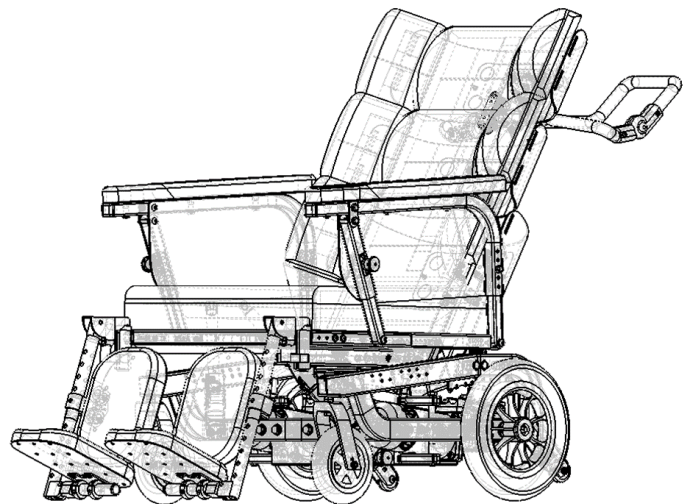

9. Possible adjustments

9.1 Adjusting the back module

When the user is placed in the wheelchair for the first time, the need for extra filling in the various back modules must be professionally assessed. If extra filling is needed, move the user out of the wheelchair, after which professionally trained staff adds or removes filling from the cushions in question.

In addition, the tilt-in-space and recline function enables changes in position and optimises the conditions in connection with moving in and out of the chair.

9.2 Other possible adjustments

Adjust leg rests to lower legs of the user. Adjust the angle of the foot plates in relation to the user's positioning of the feet. Adjust the calf support to provide the user with both support and relief of the calves.

The angle of the arm rests can be height-adjusted and adjusted in a perpendicular position or in a downward-facing position, allowing the user to move close to a table. The arm rests can also be pulled back in connection with the application and/or removal of slings.

9.3 Measuring the user

Always measure the user when the user is seated.

If help is needed in terms of measuring the user, please contact Cobi Rehab on telephone +45 7025 2522 or at cobi@cobi.dk.

The seat depth can be adjusted in several ways, e.g., by using the FitGo system or by adjusting elements in the back cushion. In addition, the seat depth can also be adjusted.

However, the latter adjustment requires a technician. Cobi Rehab recommend completing this before starting the specific adjustment.

 Risk of fingers getting caught between the seat and the frame when tilting.

 Risk of tissue getting caught between arm rest and back when reclining.

The above adjustments are made by pulling out the button on the bracket at the front of the arm rest.

The neck support bracket of the Cobi Cruise Power comfort wheelchair is universal. This allows for the installation of the most suitable neck support.

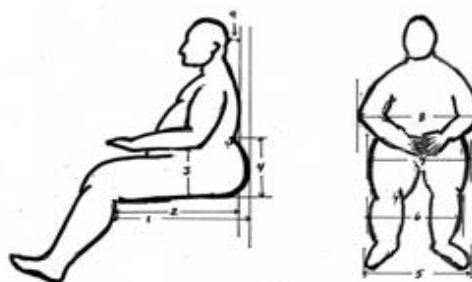

Risk of crushing or getting caught

Be careful not to get the user's tissue or fingers caught when adjusting the arm rests. This also applies when using the swivelling function of the leg rests.

10. Maintenance and cleaning

The Cobi Cruise Power comfort wheelchair is easy to clean. If the seat needs disinfecting, remove, and disinfect it using ethanol 70 - 85 % or a chlorine product of min. 1000 ppm and max. 10000 ppm.

Clean the frame, seat and arm rests of the wheelchair using water and a regular cleaning agent.

If the Cobi Cruise Power is to be washed in a laundry room at e.g., a depot or a hospital, all electrical components must be dismantled.

The dismantling and reassembly of electrical components should only be done by technically trained staff. Contact Cobi Rehab for more information on dismantling electrical components.

The joystick can be disinfected using ethanol 70 - 85 % or a chlorine product of min. 1000 ppm and max. 10000 ppm.

11. Transport and storage

When the wheelchair is not in use, store in a dry place at a temperature between - 10 - 50°C.

The Cobi Cruise Power comfort wheelchair is suitable for land transport but cannot be folded as it has a fixed frame. To avoid injuries to e.g., the back, we advise against carrying the 120 kg wheelchair.

The Cobi Cruise Power comfort wheelchair can be lifted by the frame if it is to be transported in a motorised vehicle.

Crash test

The Cobi Cruise Power comfort wheelchair has been crash-tested. This means that it can be used as a seat for a bariatric user in a motor vehicle.

Fasten the wheelchair in the motorised vehicle using the supplied Tie-Down brackets. The four brackets are marked with the Tie-Down symbol and have four points.

Lower the seat of the wheelchair to its lowest position to reduce the risk of damage.



Only use the Tie-Down bracket with approved attachment systems that comply with EU 214/2014.

When transporting the Cobi Cruise Power, we strongly recommend adjusting the seat to 0° position as a minimum. If possible, we recommend adjusting the seat to a -4° position. We also recommend adjusting the back to 97° or less.

11.1 Long-term storage

When storing the Cobi Cruise Power comfort wheelchair for longer periods of time (3+ months), store the wheelchair at 0°-30° degrees and in a humidity not exceeding 75%.

We recommend charging the battery to 40-60% prior to storage.

When putting the Cobi Cruise Power comfort wheelchair into use again after long-term storage, connect it to the power supply and charge it for at least 30 minutes.

Keep an eye on the battery capacity as the battery will discharge over time.

12. Recycling and disposal

Dispose of products that are no longer in use in an environmentally safe manner. Contact your local authority for further information on disposal.

Contact Cobi Rehab for further information on the recycling of lithium batteries and wheelchair parts.

13. Warranty

Cobi Rehab warrants that the Cobi Cruise Power comfort wheelchair is without defects on delivery. If, against all expectations, the wheelchair is subject to deficiencies or defects on receipt, please contact Cobi Rehab immediately.

The warranty period for the Cobi Cruise Power comfort wheelchair is one year from the date of purchase and covers manufacturing defects or defect on receipt. The invoice is your certificate of warranty.

The warranty does not apply to:

- products on which the serial number, batch number or the like have been removed or significantly damaged.

- products which have been repaired by unauthorised personnel.

The warranty does not cover:

- wearing parts.

This warranty does not apply when Cobi Rehab assesses that the Cobi Cruise Power comfort wheelchair has been improperly operated.

For damage caused by improper operation, an invoice will be issued for both the service and the spare parts used.

13.1 Accidents

Report any incidents relating to the use of the Cobi Cruise Power comfort wheelchair to Cobi Rehab.

13.2 After expiry of expected service life

After the expected service life, it is important that an overall assessment of the product is made before continued use.

After the expected service life, Cobi Rehab cannot guarantee the suitability and safety of the product, as Cobi Rehab has no control over how the product is used and wear and tear.

The overall assessment of the product must be carried out by qualified professionals, and as a

minimum, consideration must be given to how the product has been used, the condition of the product and its components.

Cobi Rehab can always make such an assessment.

14. Specifications

Max. user weight	325 kg
Risk class	I
Basic UDI DI	5740000100023N6
Wheelchair class	A
Expected product service life	Minimum 7 years
Crash tested	Yes, according to ISO 7176-19
Seat depth	480-600 mm, at 30 mm intervals
Back angle	90°- 120°, continuously variable
Seat angle	-4 - 13°
Height from front of seat to ground (Height stated without cushion. Add 100 mm if cushion included)	337-551 mm
Height of back rest	613 mm
Max. length excl. footrests / incl. footrests	approx. 1246 mm / approx. 1773 mm
Min. length excl. footrests / incl. footrests	approx. 987 mm / approx. 1054 mm
Seat width	550-1000 mm, at 50 mm intervals. 100 mm between 700 and 1000 mm
Max. total width	676-926 mm
Max. total height	1115 mm
Max. weight of wheelchair	120 kg
Max. height of curb which the wheelchair can safely traverse	50 mm
Max. downhill inclination	10°
Max. uphill inclination	10°
Max. sideways inclination	10°
Massive tyres	Nylon tyres with PU core
Speed at electric propulsion	6 km/h
Theoretical continuous distance at max. weight capacity	approx. 9 km
Theoretical manoeuvring distance	3.9 km
Frame tubing (material)	S355 high-tensile steel
Seat cushion filling	CMHR 50250 (base), Visco 45060 (core), CMHR 4038 (top), flame-retardant
Back cushion filling	CM 2740 (base), Cut latex and EPS-beads (the front), flame-retardant
Back and seat cushion	Covered in incontinence cover (G469 black), flame-retardant
Arm rest cushion	Foam (CMHR4250 and RF5060), cover durable imitation leather (Temskey Leather), flame-retardant
Cushion in foot and lower leg support	Foam (CMHR4038), cover durable imitation leather (Temskey Leather), flame-retardant

Push bar	S355 High-tensile steel
Wheel forks	Aluminium
Footrest tubing	Steel
Foot plate	S355 High-tensile steel
Turning radius (Pivot)	100-120 cm
Foldable	No
Battery	Lithium 50 Ah 24V
Three actuators	LINAK LA23
Control box	Curitss-Wright R-net PM120
Joystick	R-net JSM-LCD
Electric wheelchair, including components	DS/EN 12184: 2014, in accordance with ISO 7176
IP-code	IPX4
Risk assessment	EN/ISO 14971: 2012
General requirements and test methods	EN 12182:2012

15. Technical data: Charger

UY360	
Charging current	12A
Charging voltage	24V
Capacity interval	AGM / Gel /Li-on 33 - 100 Ah
Mains voltage	230V (200-240V AC)
Mains current	1,56A @ 230V
Temperature interval	-20°C - +40°C
Cable	1.6 m
Weight	1.4 kg
Cooling	Fan

16. Accessories and spare parts

Accessory	Part number
Elevation leg rest R	0115-999-006
Elevation leg rest L	0115-999-007
Cobi Cruise IV-holder with installation bracket(s)	0115-999-090
Neck support	Contact us for the choice of neck support
For spare parts, please contact Cobi Rehab on telephone +45 7025 2522 or at cobi@cobi.dk	



COBI REHAB



MANUFACTURER

Cobi Rehab
Fuglebækvej 1D
DK-2770 Kastrup
Denmark
+45 7025 2522

cobirehab.com