



## USER MANUAL

# Eclipse Tilt – bariatric wheelchair with tilt

**Manuel wheelchair in timeless design intended for users up to 270 kg. Equipped with tilt function, which ensures individual optimal comfort and positioning. Possibility of adjusting height and seat depth.**

Eclipse Tilt Wheelchair is intended users in need of a comfort wheelchair in care centers, hospitals and private homes.



**UP TO 270 kg**

- Used in rehabilitation of the mobile user.
- Possible to adjust the seat depth and angle of the backrest.
- Tilt function up to 30°.
- Extended armrests (accessory) make it easier to get in or out the wheelchair.
- Disinfectable.
- Fits through most doorways.



# Table of content

1. Safety .....	3
2. Symbols .....	5
3. General comments .....	6
4. Use .....	6
5. Construction .....	7
6. Assembly and adjustment .....	9
7. Component overview.....	14
8. Cleaning and maintenance .....	15
9. Transport and storage.....	15
10. Recycling and disposal.....	16
11. Warranty .....	16
12. Specifications .....	17
13. Accessories and spare parts .....	18
14. Troubleshooting .....	19

# 1. Safety

---



## WARNING

Do not use Eclipse Tilt Wheelchair without thorough instructions from trained staff or from persons who have received instructions in the use of the wheelchair. Improper operation may injure the user.

Using Eclipse Tilt Wheelchair for people weighing more than the maximum user weight of 270 kg increases the risk of damaging the wheelchair.

Read this user manual carefully before using the Eclipse Tilt Wheelchair. Pay particular attention to Safety Instructions marked .

Cobi Rehab assumes no responsibility for any damage to the product nor for personal injury caused by incorrect installation, incorrect mounting, or incorrect use of the Eclipse Tilt Wheelchair.

Immediately contact Cobi Rehab if parts are damaged or missing. Never use your own spare parts.

Cobi Rehab cannot be held responsible for errors or accidents occurring after repairs are made without written permission of Cobi Rehab.



## SAFETY INSTRUCTIONS

In this user manual, the symbol  indicates a safety instruction. Follow safety instructions carefully.

It is the care staff who assess whether the user for safety reasons should be restrained in the Eclipse Tilt Wheelchair during use.

Users without stand and walking abilities must always be lifted in and out of the Eclipse Tilt Wheelchair.

Eclipse Tilt Wheelchair has a max user weight of 270 kg.

The surface temperature can rise when the Eclipse Tilt Wheelchair is exposed to external heat sources, e.g., sunlight.

The widest Eclipse Tilt Wheelchair models may have difficulty passing through regular doors and emergency exits due to their width.

Do not tilt Eclipse Tilt Wheelchair without assistance.

Never stand on the frame of the Eclipse Tilt Wheelchair.

Do not stop an Eclipse Tilt Wheelchair from moving using the wheel brakes.

Lock both wheels when moving in and out the Eclipse Tilt Wheelchair.

## SAFETY INSTRUCTIONS, continued

Only use the Eclipse Tilt Wheelchair on even surface.

Do not use the Eclipse Tilt Wheelchair on ramps or slopes that slope more than 10°.

Do not drive on ramps or slopes covered with ice, oil, or water.

Do not lift the Eclipse Tilt Wheelchair in the detachable parts (armrests, wheels, backrests, footrests, etc.).

Do not remove the anti-tip supports.

Do not use the footrests to stand on during entry and exit of the Eclipse Tilt Wheelchair.

The user must not attempt to reach objects that require the user to move far forward in the seat.

The user must not try to pick up objects from the floor if it means that the user must reach far down between his knees.

The user must not try to reach objects behind the wheelchair by leaning far backwards over the backrest.

## Measurement of user

Measurement of the user is always done in a sitting position.

For help with measuring the user, please contact one of our therapists / consultants at [cobi@cobi.dk](mailto:cobi@cobi.dk).

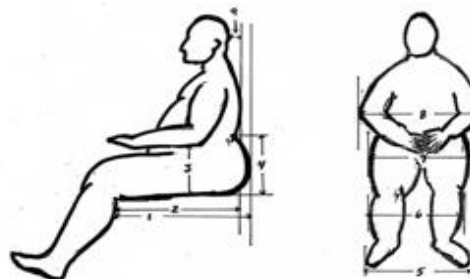

### Risk of pinching

Avoid squeezing the user's tissues and fingers when adjusting e.g., armrests or when using the leg rest's swing-away function.

## 2. Symbols

---

The following symbols are used in this user manual and/or on the product label.

	Caution!
	Declaration of conformity, Medical Device Regulation, EU 2017/745
	Manufacturer
	Medical device
<p>CE label on the product is located on frame.</p> <p>See example of labels below.</p>	



## 3. General comments

---

This user manual contains important information about the use of Eclipse Tilt Wheelchair and the target group for the wheelchair. It also includes a wide range of specifications on Eclipse Tilt Wheelchair.

The most recent version of this user manual can be found on our website. Check if the version you are reading now is the most recent.

If you need a user manual written in a larger font size, this user manual is available in PDF format at [cobirehab.com](https://www.cobirehab.com), which can be scaled up to the required font size.

You can always contact Cobi Rehab on [cobi@cobi.dk](mailto:cobi@cobi.dk) if you want more information about Eclipse Tilt Wheelchair.

Cobi Rehab reserves the right to change the product specifications without providing prior notice.

The basic UDI-number of Eclipse Tilt Wheelchair is found in the specification list.

Product safety notices and product recalls can be viewed on the website (<https://www.cobirehab.com/kunde-hos-cobi/vigtig-produktinformation/>).

## 4. Use

---

Eclipse Tilt Wheelchair is designed for indoor use in e.g., hospitals, institutions and in nursing homes.

The wheelchair can also be used in private homes and outdoors.

⚠ The large models may have difficulty getting through doorways due to their width.

Eclipse Tilt Wheelchair is intended for users up to 270 kg with limited standing and walking abilities.

Eclipse Tilt Wheelchair is equipped with tilt function, which ensures individual optimal comfort and positioning of the user.

The intended operator of the Eclipse Tilt Wheelchair is a health professional, such as a therapist, nurse, or care giver.

Intended operator can also be the user with trunk stability and functional ability to drive, steer and, use brakes on the wheelchair.

Eclipse Tilt Wheelchair can be used in environments with a temperature from 0-40°C and in a humidity between 20-75%.

### Before use

When using the Eclipse Tilt Wheelchair, the user and the therapist or another healthcare professional, should perform a variety of balance and transfer exercises to understand the safety limits of the wheelchair.

### Contraindications

Users with cognitive impairments should be monitored and guided in the use of Eclipse Tilt Wheelchair.

⚠ Eclipse Tilt Wheelchair is not intended for users who cannot sit down for a longer period.

⚠ Eclipse Tilt Wheelchair is not suitable for the extrovert reacting user.

## 5. Construction

Eclipse Tilt Wheelchair is a manual fixed frame wheelchair built with a strong steel frame, which provides maximum strength, rigidity, and long durability. It is designed so most of the user's weight rests on the rear wheels.

The tires are massive making propulsion and steering easy.

Eclipse Tilt Wheelchair is equipped with anti-tip supports, leaving the user without the risk of the wheelchair tipping when getting in and out the wheelchair. The seating plate is solid making it easier to exit the wheelchair.

Eclipse Tilt Wheelchair is equipped with tilt function, which ensures individual optimal comfort and positioning. Eclipse Tilt Wheelchair can easily tilt users up to 270 kg.

Tilting the Eclipse Tilt Wheelchair is done using the tilt lever on the side of the push handle. The user must always be informed before tilting the wheelchair so the user can lean backwards.

⚠ Be aware that the user's hands and feet are free of the wheels when the wheelchair is tilted backwards.



Eclipse Tilt Wheelchair without footrests (accessory).



Tilt function up to 30°.

### Customized options

Eclipse Tilt Wheelchair can be customized with different backrest systems meeting the needs of different users.

The strap back is designed so users with a voluminous posterior obtain good lumbar support.

Eclipse Tilt Wheelchair has adjustable seat depth, seat height and seat angle, which provides several adjustment options for the individual user.

A standard Eclipse Tilt Wheelchair is delivered without footrests but can also be ordered with swing-away footrests or elevating footrests with calf support.

Eclipse Tilt Wheelchair can be equipped with extended armrests making it easier for the

independent user to get in and out the wheelchair.

The armrests can be strengthened further.

All these options meet the needs of different bariatric body types, allowing the user:

- To drive the wheelchair forward
- To get safely in and out of the wheelchair
- To walk the wheelchair

Eclipse Tilt Wheelchair can be used with different types of seat cushions.

## Stability and balance

Always keep the wheelchair as stable as possible, so proper balance is maintained. The wheelchair is designed to stay upright during normal everyday activities if user do not move beyond the centre of gravity.

## Safe handling of Eclipse Tilt Wheelchair

Many activities will require user to reach, lean or transfer in and out of the wheelchair. These movements will cause a change to the normal balance, centre of gravity and weight distribution of the wheelchair. Therefore, practice leaning, reaching and transfer activities before the user attempts an active use of the wheelchair.

With attention to technique and practice of transfer techniques, the user can feel safe and get around safely.



Gas Strut Assembly.

## Transfer to and from other seats

1. Position the wheelchair as close as possible alongside the other seat, with the front casters pointing toward it. Engage wheel locks. Shift body weight into seat with transfer.
2. During independent transfer, little or no seat platform will be beneath the user. Use a transfer board if possible.



Transfer to and from other seats.

## Change of weight distribution

To become familiar with the specific safety limits of the wheelchair, the user should practice various combinations of bending forward, reaching out, and moving to all sides with qualified caregivers before actively using the wheelchair alone.



Change of weight distribution.

## Reaching out, leaning, or bending forward

Proper positioning is essential for the safety of the user.

When reaching, leaning, bending forward, it is important to use the front casters as a tool to maintain stability and balance.

⚠ Do not attempt to reach or pick up objects if it means moving forward in the seat or reaching down between the knees.



FIG. 3

Reaching out, leaning, or bending forward in Eclipse Tilt Wheelchair.



# 6. Assembly and adjustment

---

Upon receipt, check that the cardboard box contains

- One Eclipse Tilt frame with two rear wheels and two front castors
- Two anti-tip tubes
- One pair of armrests

## 6.1 Back rest

The seat frame has two bolts mounted along the left and right sides of the back of the seat frame.

Remove the screws on each side and insert the entire backrest into the back of the seat frame. Then refit the bolts and tighten them completely.

The wheelchair back has a built-in push handle, on which tilt levers are mounted.

The tilt function works when the steel ball (at the end of the cable) is in the slot on the tilt handle and the cable is securely attached to the release.

### Adjustment of the back frame

Adjust the seat depth and back angle to suit the desired angle of the seat. The removable backrest holders are fastened with four bolts, which are mounted in the pre-drilled hole patterns. Make sure the bolts are the same on both sides.

Cobi Rehab or other professionals can adjust the height of the back frame by shortening the pipes to the desired length with a scraper or pipe cutter.

## 6.2 Anti-tip tubes

The anti-tip holders are bolted to the frame. The anti-tip tubes have two length adjustment options.

 Do not operate the Eclipse Tilt Wheelchair without anti-tippers installed. Anti-tippers are mandatory for safety and warranty protection.

- One Eclipse Tilt Wheelchair backrest with built-in push bar with tilt lever.

If cushion, footrests, headrest, or Transit Tie-Down System have been purchased, this can also be found in the cardboard box.

No tools for mounting are included.

### Adjustment of upholstery

The straps on the back of the back padding can be adjusted by either loosening or tightening them.

Start by loosening the straps, after which the user is placed in the wheelchair, so the upper part of the padding supports the upper part of the user's back. Then tighten the straps.

### Upholstery placement

Check regularly that the upholstery and / or the inner lining are not damaged or weakened. Replace damaged padding or loose lining immediately.

 The fire-retardant effect of the upholstery is reduced if it is machine-washed or have been damp.

### To install the anti-tip tubes

1. Press and hold the release button on the anti-tip tube.
2. Insert the anti-tip tube into the receiver until it locks into position.

## Assembly and adjustment, continued

### 6.3 Armrests

#### Adjusting Armrests Height

Unlock the armrest by pressing the black release button at the top of the front of the armrest while moving the armrest up or down.

Adjust the armrest to the desired height. The armrest locks in place when the release button pops out of one of the holes to adjust the height of the armrest.

#### Removing the armrests

Release the armrest by pressing the black release lever on the front of the armrest (just above the seating plate) while pulling the armrest upwards.

#### Extended armrests

Eclipse Tilt Wheelchair can be equipped with extended armrests (50 cm), which makes it easier for the independent user to sit and get up from the wheelchair.

#### Armrest upholstery

If the padding is cracked or the mounting screws are not covered, replace the padding immediately. This is done to maintain the comfort for the user.

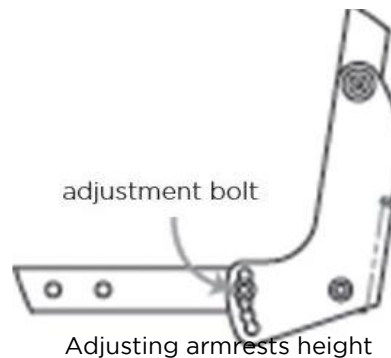

### 6.4 Backrest

#### Adjusting the back angle

The angle between the seat and the backrest can be set at a maximum upright angle of 90 ° -122 °. Two bolts must be removed to change the angle.

1. Loosen and remove the displayed angle adjustment bolt. There are two bolts, one on each side of the wheelchair.
2. Adjust the bracket to the desired angle and refit the bolts.
3. Tighten the nuts again.

⚠ After any adjustment, it is important to check that all parts are properly tensioned before using the wheelchair again.

⚠ The lock nuts must be used a maximum of five (5) times to ensure that they lock properly. Replace the lock nuts if they are worn.

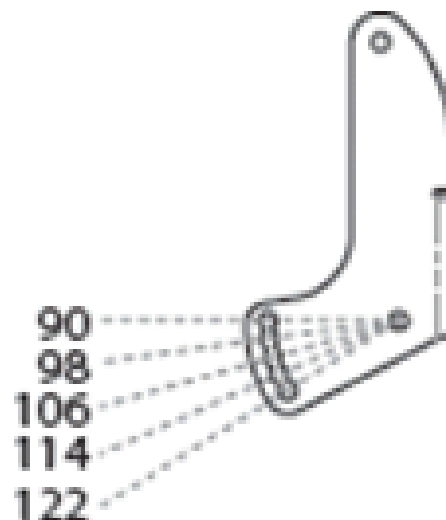

Adjusting the Back Angle.

## Assembly and adjustment, continued

### 6.5 Removing/Installing the Rear Wheels/Axles

The rear wheels are removed with a 3/4" socket wrench and a 3/4" fork wrench.

When the wheelchair is equipped with axle bolts, the heads of the axle bolts must be located on the inside of the frame with the nuts mounted on the outside of the rear wheel hubs.

If the axle bolts are mounted upside down, the seat frame may abut the ends of the axle bolts when attempting to tilt the wheelchair.

During assembly, the axle bolts are tightened so the rear wheels are in place, but not so much that they cannot turn freely.

The rear wheel is mounted on the wheelchair in reverse order.

#### Adjusting the Rear Axle Position

The position of the rear wheel can be adjusted forwards or backwards.

1. The axle plates are held close to the lower frame by six bolts (12 in total). The position of the rear wheels is changed by loosening the bolts slightly, after which the rear wheel axles are moved forwards or backwards as required.

Before tightening the bolts again, make sure the rear axles are at the same distance from the rear end of the lower frame. There are measuring marks on the bottom of the lower frame.

2. The anti-tip tubes are inserted into the holders at the back of the frame, so the rollers prevent the wheelchair from tipping over if the center of gravity moves too far back.

⚠ Make sure the wheelchair is stable in all tilted / non-tilted positions before releasing the wheelchair for use.

### 6.6 Installing/Replacing Front Casters

⚠ After adjusting, always make sure parts are properly replaced and tightened before using the wheelchair.

1. Remove the bolt.
2. Slide out caster fork assembly.
3. Reassemble by reversing step 1-2.
4. Test the wheelchair for manoeuvrability.

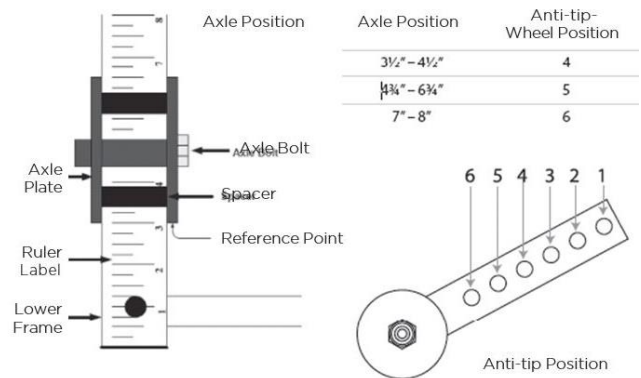

Adjusting The Rear Axle position.

## Assembly and adjustment, continued

### 6.7 Seat-to-Floor Height

1. Remove the grub bolts that secure the upper seat frame to the lower base frame; there are two Allen bolts located on the outside of the seating plate (one screw on each side).
2. Move the seat frame to the desired height. There are three height settings.
3. Remove the Allen bolt, which connects the lower part of the gas strut to the base frame.
4. Move the lower end of the gas strut (Strut-A, -B or -C) to fit the selected seat height (SH-A, -B or -C) as shown.
5. Seating plate must be placed almost level when the gas strut is fully extended.

⚠ All screws and nuts must be assembled correctly.

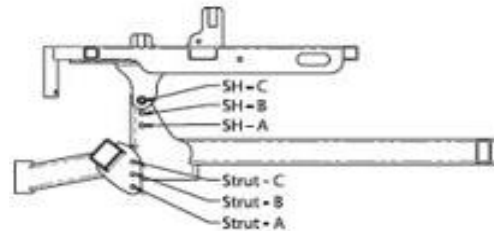

Adjusting The Seat-To-Height-Floor.

### 6.8 Adjustable seat tilt

1. The tilt angle is adjusted by activating the tilt lever on the side of the push handle or on the armrest, depending on how the wheelchair is configured.
2. Lower the rear of the seat to the desired height and release the tilt handle. The seat now 'locks' at the desired tilt angle.

Be aware that the tilt handle may be mounted on the left or right side of the push handle on the backrest or on the left or right armrest.

⚠ When tilting the wheelchair, it is important to hold the push handle firmly, so the seat does not drop too quickly.

### 6.9 Tilt restriction

The tilt restriction is a yellow telescopic tube next to the gas strut. It has 6 holes for setting the tilt stop.

Insert the shiny 10-32" Allen screw into the desired position.

⚠ After adjusting, the parts must always be properly replaced and tightened before using the wheelchair.

## 6.10 Adjustable gas strut and cable assembly

### Adjusting the cable tension

If the wheelchair tilts (while the user is sitting in it), even if the tilt lever is not activated and if the wheelchair does not tilt, even if the tilt lever is activated, it is because the cable "stretches" over time.

#### How to adjust the tension of the cable

Beforehand, check that the steel ball (at the end of the cable) is in the slot on the tilt handle and that the cable is securely attached to the release.

Lack of tilt after activating the trigger means the cable is too loose.

1. Tighten the cable by removing the rubber sleeve around the gas strut housing on the cable.
2. Turn the 'tighten nut' so that less cable is visible over the nut.

Tilting the wheelchair without activating the trigger means that the cable is too tight and must be loosened.

1. Loosen the cable by removing the rubber sleeve around the gas strut housing on the cable.
2. Turn the 'tighten nut' so that more cable is visible over the nut.

#### Removing and Installing the Gas Strut Actuator Cable

1. Grab the cable just in front of the trigger. In one smooth motion, pull straight down until the cable releases from the end of the trigger. Pull the metal cable-end out from the side of the trigger.
2. Disconnect the opposite end of the cable from the strut, using a 7/16" and a 3/8" open end wrench.
3. To install the new cable, refit to the strut by reversing step 2. Be sure to connect the cable ball to the actuating lever.
4. Re-fit the metal cable end by inserting into the side of the trigger.
5. Feed the cable through to the front of the trigger.
6. Hold the plastic parts in place and press the trigger, the cable should snap in place, if not you may need to push it until it snaps.

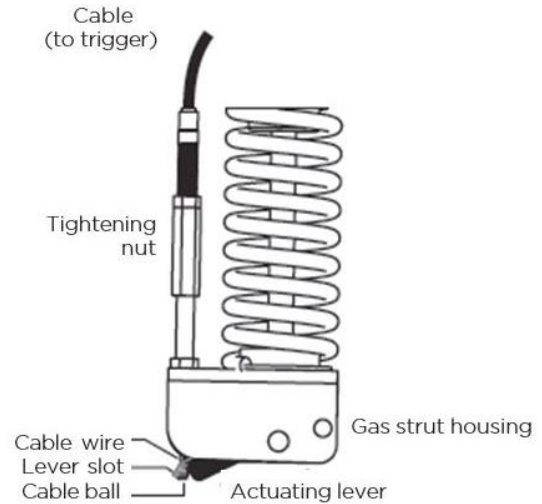

Adjusting the cable tension.

## 7. Component overview

---

1. Removable Armrest
2. Wheel Lock
3. Gas Strut Assembly (yellow spring)
4. Swing Away Front Rigging
5. Footrest
6. Front Castors
7. Tilt Lever
8. Rear Wheels
9. Push handle
10. Backrest
11. Rear Axle Bolt
12. Lower frame
13. Upper Seat Frame
14. Seat Cushion



## 8. Cleaning and maintenance

---

Eclipse Tilt Wheelchair's seat, frame, backrest upholstery and push handles can be cleaned with water and an ordinary detergent.

⚠ Wet or damp backrest upholstery will reduce the flame retardant effect.

### Disinfection

Seat, frame, backrest upholstery and push handles can be disinfected with ethanol 70-85% or a chlorine product 1000-1200 ppm.

The wheelchair cushion can be changed when transferred to a new user.

⚠ Disinfect Eclipse Tilt Wheelchair when passed on to a new user. This is done to avoid cross-contamination and infections.

Local cleaning and disinfection procedures must always be followed.

### Maintenance

1. Check all nuts and bolts are tight before using the Eclipse Tilt Wheelchair. Check all parts for wear and damage and replace parts where required.
2. Keep axles free from dirt and fluff to ensure the mechanism locks correctly and the wheels can turn freely.
3. Lubricate the axles at least once a month (use a 3-in-1 oil or a similar product).
4. Periodically check the wheels and tyres for cracks and wear and replace as required.
5. Periodically check the hand rims are securely attached to the wheel.

## 9. Transport and storage

---

When Eclipse Tilt Wheelchair is not in use store it dry and in temperatures between -10° - 50°C.

Eclipse Tilt Wheelchair is (without user) suitable for land freight.

Eclipse Tilt Wheelchair is not foldable.

To avoid injuries on the staff, it is not recommended to carry the 40 kg heavy wheelchair.

The wheelchair can be lifted in the frame if it must be transported without user in a vehicle.

⚠ Eclipse Tilt Wheelchair is not crash tested. Therefore it cannot be used as a seat in a vehicle.

### 9.1 Long-term storage

Eclipse Tilt Wheelchair should be stored in the dark and covered with a blanket or similar.

Eclipse Wheelchair should be stored between -10° - 50°C in terms of temperature.

Check regularly that the wheelchair has not become wet or has suffered other damage during storage.



## 10. Recycling and disposal

---

Dispose of products that are no longer in use in an environmentally safe manner. Contact your local authority for further information on disposal.

Contact Cobi Rehab for further information on the recycling of wheelchair parts.

## 11. Warranty

---

Cobi Rehab warrants that the Eclipse Tilt Wheelchair is without defects on delivery. If, against all expectations, the wheelchair is subject to deficiencies or defects on receipt, please contact Cobi Rehab immediately.

The warranty period for the Eclipse Tilt Wheelchair is one year from the date of purchase and covers manufacturing defects or defect on receipt. The invoice is your certificate of warranty.

The warranty does not apply to

- products on which the serial number, batch number or the like have been removed or significantly damaged.

- products which have been repaired by unauthorised personnel

The warranty does not cover:

- wearing parts

This warranty does not apply when Cobi Rehab assesses that the Eclipse Tilt Wheelchair has been improperly operated.

For damage caused by improper operation, an invoice will be issued for both the service and the spare parts used.

 Lack of maintenance can damage the product, shorten the life, or affect the performance of the Eclipse Tilt Wheelchair.

### 11.1 Unintended event

Report any incidents relating to the use of Eclipse Tilt Wheelchair to Cobi Rehab.

### 11.2 After expiry of expected service life

After the expected service life, it is important that an overall assessment of the product is made before continued use.

After the expected service life, Cobi Rehab cannot guarantee the suitability and safety of the product, as Cobi Rehab has no control over how the product is used and wear and tear.

The overall assessment of the product must be carried out by qualified professionals, and as a

minimum, consideration must be given to how the product has been used, the condition of the product and its components.

Cobi Rehab can always make such an assessment.



## 12. Specifications

Maximum user weight	270 kg
Risk class	I
Basic UDI	13829
Expected product service life	Minimum 7 years
Crash tested	No
Seat depth	410 - 560 mm
Seat width	550 - 820 mm
Seat height	410 - 510 mm
Strap back rest	Polypropylene
Back angle	90 - 122°
Total length without footrests	870 mm
Total width	Seat width + 250 mm
Weight wheelchair	40 kg
Slope downhill	Max 10°
Slope uphill	Max 10°
Slope laterally	Max. 10°
Rear wheel	24" (580 mm x 30 mm) massive PU
Front wheel	125 mm nylon med PU
Frame material	Steel
Seat upholstery	Polyester with PVC
Push bar, adjustable	Yes
Wheel forks	HD steel fork
Footrest tubes	6061-T6 Aluminium
Footplate	6061-T6 Aluminium/nylon with fiberglass
Foldable	No
Risk assessment	EN ISO 14971:2012
General requirements and test methods	ISO 7176-1, -3, -5, -7, -8, -16 og -19

## 13. Accessories

---

<b>Accessories</b>	<b>Item number</b>
IV complete (IV holder, bracket for mounting and thumb screws)	0180-999-007
O2 holder, 12-15 cm	0100-999-021
Headrest	0120-999-103
Table (for seat width 55-72 cm)	0100-999-001
Increase adapter seat height	0120-999-078
Armrest 50 cm, right	0120-999-077
Armrest 50 cm, left	0120-999-008
Footrest swing away left	0120-999-009
Footrest swing away right	0120-999-006
Footrest elevation, right	0120-999-007
Footrest elevation, left	0120-999-065
For spare parts please contact Cobi Rehab +45 7025 2522 or <a href="mailto:cobi@cobi.dk">cobi@cobi.dk</a>	

## 14. Troubleshooting

Problems	Solutions
Slow turning or driving	Check if nuts and screws are loose
The front castors vibrate	
The wheelchair creaks and rattles	
The wheelchair seems loose	
The wheelchair pulls to the right	Check the angle of the front castors
The wheelchair pulls to the left	
Slow turning or driving	
The front castors vibrate	
The wheelchair pulls to the right	Check that both front wheels touch the ground at the same time
The wheelchair pulls to the left	
The front castors vibrate	



**COBI REHAB<sup>®</sup>**  
The Positioning Company

---

**DEALER**

**Cobi Rehab**  
Fuglebækvej 1D  
DK-2770 Kastrup  
Denmark  
+45 7025 2522  
[cobirehab.com](http://cobirehab.com)



**MANUFACTURER**

**PDG Mobility**  
PDG Product Design Group Inc.  
#103-318 East Kent Avenue South,  
Vancouver  
BC V5X 4N6  
Tel.: (604) 323-9220  
Fax: (604) 323-9097  
E-mail: [info@pdgmobility.com](mailto:info@pdgmobility.com)  
[www.pdgmobility.com](http://www.pdgmobility.com)