



COBI REHAB[®]
The Positioning Company

USER MANUAL

Minimaxx Wheelchair with Push Motor

**Foldable and strong manual wheelchair with a push motor.
Designed for bariatric users.**

Minimaxx Wheelchair Push Motor is intended for users weighing up to 200/325kg.

The wheelchair is used indoors and outdoors at hospitals, institutions care centers. It is available in four seat widths, 56 cm, 61 cm, 66 cm, and 71 cm.



Scan the code and find more the product on the Danish AssistData.



Cobi Rehab and Cobi Rehab suppliers comply with the UN conventions on child labour and forced labour as well as ILO 029, C132 and C182.

Tabel of content

1. Safety	3
2. Symbols	4
3. General comments	5
4. Use	5
5. Component overview	6
6. Assembly instructions	7
7. Driving instructions	11
8. Charging instructions	12
9. Cleaning and maintenance	13
10. Disposal	13
11. Warranty	14
12. Specifications	15
13. Ordering	16



1. Safety



WARNING

Do not use Minimaxx Wheelchair Push Motor without thorough instructions from trained staff or from persons who have received instruction in the use of the wheelchair. Improper operation may injure the user.

Using Minimaxx Wheelchair Push Motor for people weighing more than the maximum user weight of 200/325 kg increases the risk of damaging the wheelchair.

Read this user manual carefully before using the Minimaxx Wheelchair Push Motor. Pay particular attention to Safety Instructions marked with

Cobi Rehab assumes no responsibility for any damage to the product nor for personal injury caused by incorrect installation, incorrect mounting, or incorrect use of the Minimaxx Wheelchair Push Motor.

Immediately contact Cobi Rehab if parts are damaged or missing. Never use your own spare parts.

Cobi Rehab cannot be held responsible for errors or accidents occurring after repairs are made without written permission of Cobi Rehab.



SAFETY INSTRUCTIONS

Minimaxx Wheelchair Push Motor is intended for users weighing up to 200 kg.

Minimaxx Wheelchair Push Motor can however be used by users weighing up to 325 kg, but the power of the engine decreases when the user weight exceeds 200 kg. The product service life of the Push Motor is also shortened if the user weight exceeds 200 kg.

Never use Minimaxx Wheelchair Push Motor on soft or uneven surface.

Lack of maintenance can damage the product, shorten the life, or affect the performance of the Minimaxx Wheelchair Push Motor.

Do not use Minimaxx Wheelchair Push Motor as a seat in a motorised vehicle since it is not crash tested.

Minimaxx Wheelchair Push Motor can tip over, sustain damage, or break if used by a user weighing more than 325 kg.









Do not stand on the footrests. This can make the wheelchair tip forward.











Please notice that Minimaxx Wheelchairs Push Motor with a total width over 85 cm may have trouble getting through certain doorways.

Engage both wheel locks during transfer in and out of the wheelchair.

Always remember to disinfect Minimaxx Wheelchair Push Motor when transferred to a new user. This is done to avoid cross-contamination and infections.

2. Symbols

The following symbols are used in this user manual and/or on the product label.	
	Caution!
	Declaration of conformity, Medical Device Regulation, EU 2017/745
IP31	Ingress Protection Ratings Guide
	Cobi Catalogue number
	Serial number
	Year of manufacture
	Manufacturer
	Medical device
	Max. user weight
	Consult the manual
CE-Label on the product is located on frame. See example of label below.	

	Cobi Rehab ApS Fuglebækvej 1D DK-2770 Kastrup Tel.: +45 70252522			
	Minimaxx Push 0110-056-000			200 /325 KG
	0050130		MADE IN TAIWAN	
	2020			

3. General comments

This user manual contains important information about the mounting of a push motor on the Minimaxx Wheelchair and the target group for the Minimaxx Wheelchair with Push Motor. It also includes a wide range of specifications on the Push Motor.

The most recent version of this user manual can be found on our website. Check if the version you are reading now is the most recent.

If you need a user manual written in a larger font size, this user manual is available in PDF format at cobirehab.com, which can be scaled up to the required font size.

You can always contact Cobi Rehab on +45 7025 2522 or cobi@cobi.dk if you want more information about Minimaxx Wheelchair Push Motor.

Cobi Rehab reserves the right to change the product specifications without providing prior notice.

The UDI number of the Minimaxx Wheelchair Push Motor appears on the label, which is located on the side of the frame.

Product safety notices and product recalls can be viewed on the website (<https://www.cobirehab.com/kunde-hos-cobi/vigtig-produktinformation/>).

4. Use

The Push Motor is intended for mounting on a Minimaxx Wheelchair. Minimaxx Wheelchair Push Motor has a user weight up to 200 kg.

Minimaxx Wheelchair Push Motor is used indoors and outdoors at hospitals, institutions, care centres, and private homes.

⚠ Minimaxx Wheelchair Push Motor can however be used by users weighing up to 325 kg, but the power of the engine decreases when the user weight exceeds 200 kg.

The estimated service life of the Push Motor is also shortened if the user weight exceeds 200 kg.

⚠ Never use Minimaxx Wheelchair Push Motor on soft or uneven surface.

⚠ Do not step on the footrests during entry and exit. The wheelchair can tip over or fall over with the risk of injury to the user.

Always consult a therapist before assigning a Minimaxx Wheelchair Push Motor to a user.

Contraindications

There are no known contraindications associated with the use of the product.

4.1 General use of a Minimaxx Wheelchair

The footrests can carry 100 kg each. The footrests can be adjusted sideways. This benefits users with a lot of tissue of the inner thighs.

Minimaxx Wheelchair Push Motor is available in four seat widths, 56 cm, 61 cm, 66 cm, and 71 cm.

Common to all models is a seat height of 43 cm and a seat depth of 46 cm.

The total width of all models is 14 cm more than the seat width.

⚠ Please notice that Minimaxx Wheelchairs Push Motor with a total width of more than 85 cm may have troubles getting through certain doorways.

Choice of size for user

Choice of size depends on the user's body shape. Contact cobi@cobi.dk for advice and guidance before ordering.

Always measure user sitting on solid ground. This can be done by placing e.g., a book on the side of the user where the user is widest. Then measure the distance between the two books.

5. Component overview

The following parts are supplied with the Push Motor

Remote control

- 1. Remote control
- 2. Remote console
- 3. Thumbscrew
- 4. Two hardware bolts
- 5. Upper handle brackets
- 6. Three spacers
- 7. Speeder
- 8. Lower handle bracket

Wheelchair bracket

- 9. Two hub bushings
- 10. Two locknuts
- 11. Two splices
- 12. Two thumbscrews
- 13. Two protection caps

Push motor

- 14. Cord for remote control
- 15. Battery console
- 16. Lifting strap
- 17. Poles
- 18. Profile tires
- 19. Battery
- 20. Battery charger

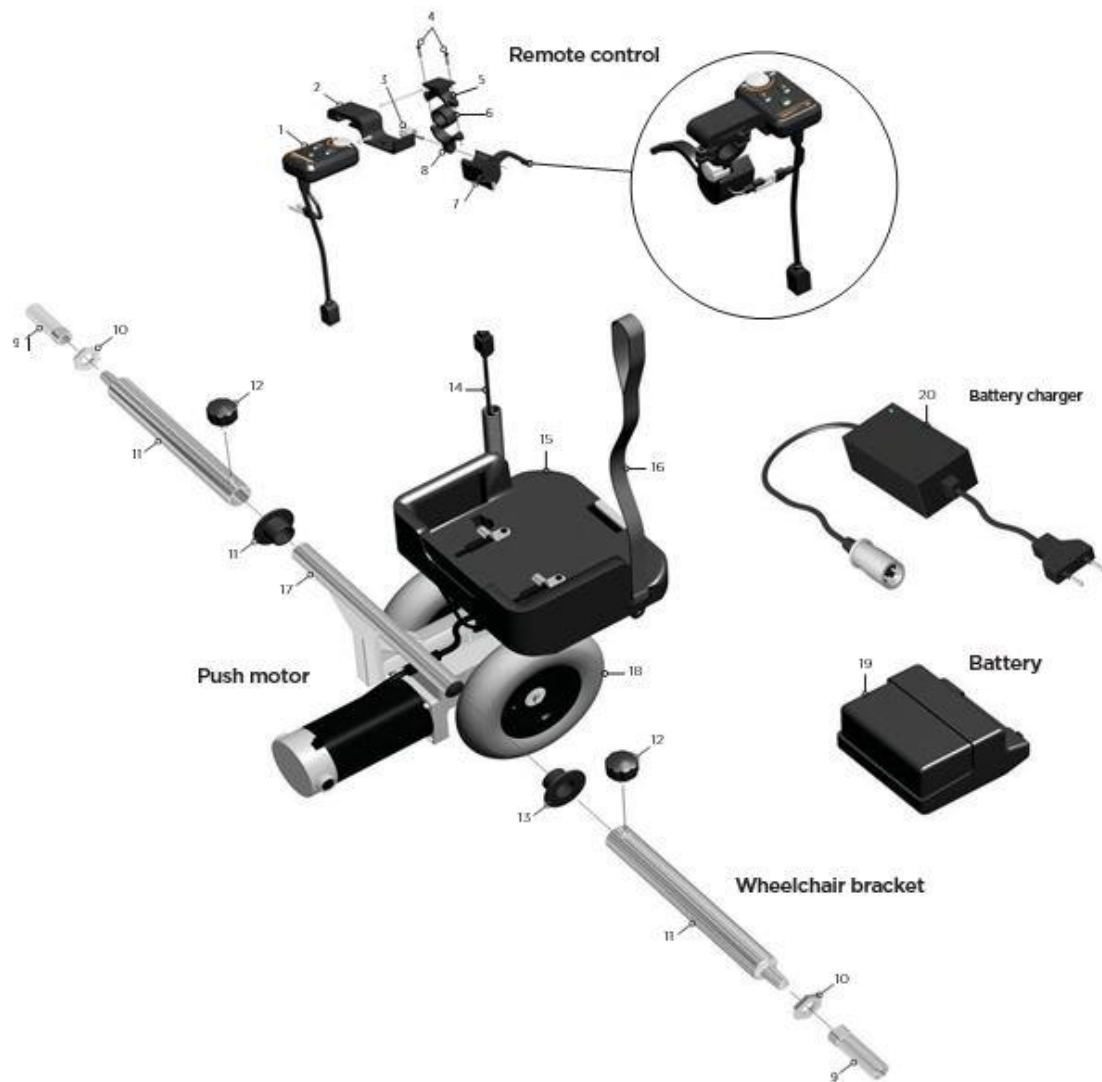

6. Assembly instructions

These assembly instructions demonstrate how The Push Motor is mounted correctly on Minimaxx Wheelchair.

Remember to charge the battery before using the Push Motor.

See Charging instructions on page 12.

Fig. 1

Start by mounting the battery (19) on the Push Motor battery console (15). The battery is locked when it is pushed to the bottom of the console.

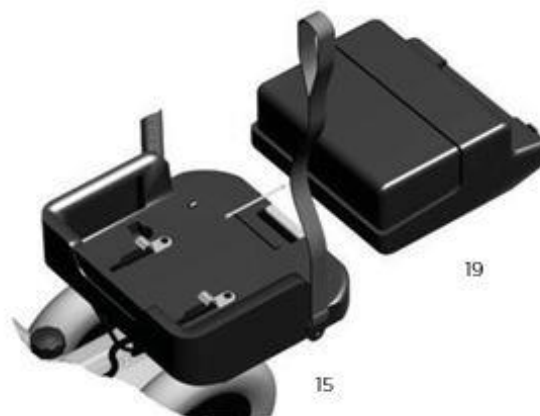

Lock the parking brakes before the Push Motor is mounted on the Minimaxx Wheelchair frame.

This prevents the wheelchair from moving during installation.

Fig. 2



Mount the two hub bushings (9) and the locknuts (10) on Minimaxx Wheelchair.

Screw the hub bushings in the front threaded hole on Minimaxx Wheelchair right and left frame.

Mount the locknuts on the inside of the frames.

Fig. 3

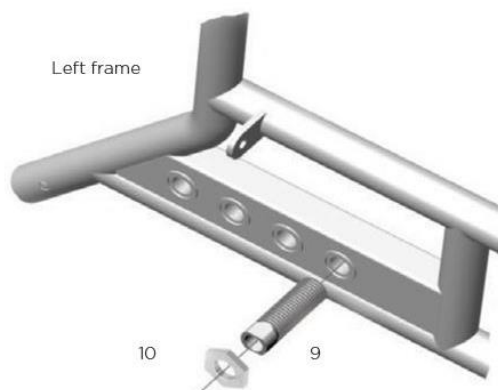

Remove the protection caps (13) first.

Then slide the splices (11) with thumbscrew (12) onto the pole (17). Push Motor is placed underneath Minimaxx Wheelchair, so the ends of the splices are in front of the hub bushings.

Fig. 4



Slide the splices out to each side until the ends rest in the hub bushings.

Lock the splices onto the pole with the thumbscrews.

The Push Motor is now mounted on the Minimaxx Wheelchair frame.

Fig. 5



Mount the Push Motor remote control on Minimaxx Wheelchair's right push handle (23).

Push a suitable spacer into the push handle tailpipe.

Upper and lower handle bracket is tightened around the spacer with the two supplied mounting bolts (4).

Fig. 6



Use the thumbscrew (3) to screw the Push Motor speeder onto the lower handle bracket.

Push the remote console (2) over the upper handle bracket. Click the remote control (1) on the console.

Connect the connectors to the accelerator and the remote control.

Fig. 7

Fig. 7

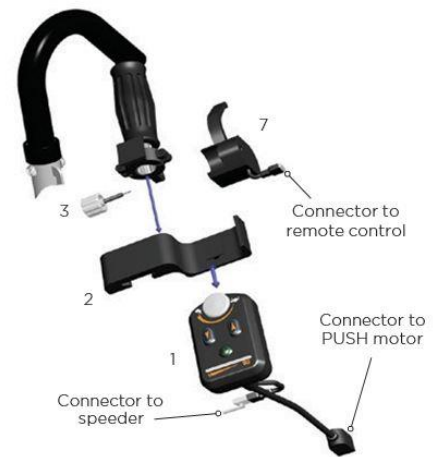

The remote control is now assembled.

The speeder can be placed on both sides of the push handle.

On a Minimaxx Wheelchair Push with disc brakes, the accelerator will automatically have to be placed opposite of the disc brake.

Fig. 8

Fig. 8



Connect the Push Motor remote control to the Push Motor.

Stretch the spiral cord and connect it to the Push Motor cord of the remote control.

The remote control and the Push Motor are now ready for use.

Fig. 9

Fig. 9



The Push Motor can be lifted from the driving surface when not needed.

A lifting strap hook (21) is included with the Push Motor set and is mounted instead of the height adjustment screw for the push handle (24).

Fig. 10



The lifting strap (16) is mounted on the Push Motor.

Adjust the length of the strap so the wheels on The Push Motor are lifted approx. 2-3 cm over the driving surface when the lifting strap hangs on the lifting strap hook.

Fig. 11



Release Minimaxx Wheelchair's parking brakes and take the lifting strap of the lifting strap hook.

The Push Motor is now ready for use.

We recommend reading the Driving instructions page 11 before using Minimaxx Wheelchair with Push Motor.

Fig. 12



7. Driving instructions

Always perform the first ride with the Minimaxx Wheelchair Push in a place with plenty of space, a level surface, and no passenger. It ensures a safe first acquaintance with the Push Motor.

Please check that the Push Motor battery is fully charged before removing it from the battery charger.

A red charge light shows that the battery is charging. The charge light on the charger turns green when the battery is fully charged. See Charging instructions on page 12.

Lower the Push Motor onto the driving surface and position the lifting strap so it cannot be entangled in the wheels.



Fig. 1

Turn on the power on the Push Motor remote control by using the ON/OFF button (1).

The battery indicator of the remote control (2) shows with a dash of green light how much power there is left on the battery. Determine with the buttons (3) and (4) whether the Push Motor should drive forward or backward. The blue light (5) and the green light (6) indicate the selected direction.

Adjust the Push Motor top speed on the speed regulator of the remote control (7).

Select “turtle” for low speed and “hare” for high speed. It is recommended to start with “turtle”.

The Push Motor will drive the wheelchair forward when the remote control speeder is activated.

When letting go of the speeder the wheelchair stops instantly. For more speed push the speed regulator to “hare”.

When going downhill let slightly go of the speed regulator to reduce speed.

On very steep slopes the wheelchair must be driven backwards down the hill.



Fig. 2

⚠ WARNING

- Turn off the ON/OFF button during longer breaks to avoid errors if the wheelchair is vacated.
- Lock the parking brakes of the wheelchair when the wheelchair is vacated.

8. Charging instructions

Connect the Push Motor to the battery charger after use. Then the battery is charged and ready for the next trip.

Fig. 1

The battery charger fits into a standard 230V wall outlet and the charging connector on the battery.

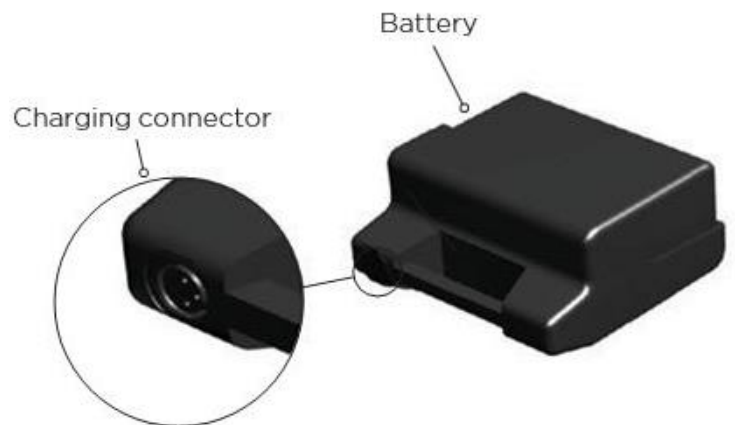

The light on the charge light is red while charging is in progress. The charge light turns green when the battery is fully charged.

Be aware that the charge light is also green if the charger gets 230V but is taken out of the battery.

With normal use of the Push Motor charging the battery will take 6-8 hours.

If the battery is run almost empty, charging will take up to 12 hours.

Fig. 2



⚠ WARNING - AVOID ACCIDENTS AND POWER FAILURES

- Remember that Push Motor can move during charging!
- Remember that Push Motor must be fully charged before and after storage.
- Remember that Push Motor use power when the remote control is on.

9. Cleaning and maintenance

9.1 Cleaning and disinfection

Minimaxx Wheelchair Push Motor can be wiped off with a cloth dipped in water with ordinary detergent.

Disinfection

The Push Motor can be disinfected with ethanol 70-85% or a chlorine product 1000-1200 ppm.

⚠ Remember to disinfect a Minimaxx Wheelchair when transferred to a new user. This is done to avoid cross-contamination and infections.

Local cleaning and disinfection procedures must always be followed.

9.2 Maintenance

⚠ The product service life of the Push Motor is extended when the motor and the various supplied parts are kept free of dirt and grime.

See section **Cleaning and Disinfection** above.

10. Disposal

Dispose of products that are no longer in use in an environmentally safe manner. Contact your local authority for further information on disposal.

Contact Cobi Rehab for further information on the recycling of wheelchair parts and batteries.

11. Warranty

Cobi Rehab warrants that the Minimaxx Wheelchair Push Motor is without defects on delivery. If, against all expectations, the wheelchair and the motor are subject to deficiencies or defects on receipt, please contact Cobi Rehab immediately.

The warranty period for the Minimaxx Wheelchair Push Motor is one year from the date of purchase and covers manufacturing defects or defect on receipt. The invoice is your certificate of warranty.

The warranty does not apply to:

- products on which the serial number, batch number or the like have been removed or significantly damaged.

- products which have been repaired by unauthorised personnel.

The warranty does not cover:

- wearing parts.

This warranty does not apply when Cobi Rehab assesses that the Minimaxx Wheelchair Push Motor has been improperly operated.

For damage caused by improper operation, an invoice will be issued for both the service and the spare parts used.

 Lack of maintenance can damage the product, shorten the life, or affect the performance of the Minimaxx Wheelchair Push Motor.

11.1 Unintended event

Report any incidents relating to the use of Minimaxx Wheelchair Push Motor to Cobi Rehab.

11.2 After the product expiry

After the expected service life, it is important that an overall assessment of the product is made before continued use.

After the expected service life, Cobi Rehab cannot guarantee the suitability and safety of the product, as Cobi Rehab has no control over how the product is used and wear and tear.

The overall assessment of the product must be carried out by qualified professionals, and as a

minimum, consideration must be given to how the product has been used, the condition of the product and its components.

Cobi Rehab can always make such an assessment.

12. Specifications

Maximum user weight for efficient push motor	200 kg
Battery	24V 450W 4,5 amp.
Weight battery	9 kg
Total weight of the Push Motor	23 kg
Tire size	500mm x 200mm (massive tires) x 2
Charger capacity	Off Board (1.8A)
Battery capacity	2 pcs 12V 12ah
Maximum speed	4 km/h
Gradient	8°
Reveres function	OK
Estimated product service life	7 years
ISO classification	12 23 12 02
Risk class	I
Basic UDI	5740000100001MU
The surface temperature of the Push Motor can increase or decrease when exposed to external sources of heat or cold.	

13. Ordering

Model	Seat width cm	Seat depth cm	Item number
Minimaxx Push Motor with disc brakes, incl. footrests	56	46	0110-056-000
Minimaxx Push Motor with disc brakes, incl. footrests	61	46	0110-061-000
Minimaxx Push Motor with disc brakes, incl. footrests	66	46	0110-066-000
Minimaxx Push Motor with disc brakes, incl. footrests	71	46	0110-071-000
Push motor, complete			0110-999-010
Sports armrests, pair			0100-999-006
Table			0100-999-001
IV holder and O2 holder, diameter 10 cm			0100-999-020
Footrest swing-away, right			0100-999-010
Footrest swing-away, left			0100-999-011
Calf/amputation support, right			0100-999-015
Calf/amputation support, left			0100-999-016
Crutch holder			0100-999-022



COBI REHAB[®]
The Positioning Company



MANUFACTURER

Cobi Rehab
Fuglebækvej 1D
DK-2770 Kastrup
Denmark
+45 7025 2522
cobirehab.com